EARTH STATION VERIFICATION ASSISTANCE
ESOG 130 – ISSUE 3 - REV. 1

February 2022



eUTELSAT



Earth Station Verification Assistance (ESVA)

ESOG 130 – Issue 3 - Rev. 1

February 2022

Contents

FOREWORD	vi
1 OVERVIEW ESOG MODULES	7
1.1 VOLUME I: Eutelsat S.A. SYSTEM MANAGEMENT AND POLICIES	7
1.2 VOLUME II: Eutelsat S.A. SYSTEMS OPERATIONS AND PROCEDURES	7
2 INTRODUCTION	8
3 ESVA REQUIREMENTS	9
3.1 Earth Station Preparation	9
3.2 Test Coordination.....	9
3.3 Space Segment Access	10
3.4 Weather Conditions	10
3.5 Antenna Alignment	10
3.6 Check List.....	11
4 TEST EQUIPMENT	12
4.1 RF Power Meter	12
4.2 RF Spectrum Analyser.....	12
4.3 Signal Source.....	12
4.4 Temporary Approval or Modification of an Existing Authorisation to Operate.....	12
5 SPACE SEGMENT ACCESS TEST	14
5.1 Test Objectives.....	14
5.2 Principle.....	14
5.3 Step-by-Step Procedure.....	15
5.4 Example for Spectrum Analyser Setting.....	16
6 POLARIZATION ALIGNMENT	17
6.1 Test Objectives.....	17
6.2 Principle.....	17
6.3 Step-by-Step Procedure.....	18
6.4 Example for Spectrum Analyser Setting.....	19
7 EIRP (INCLUDING TRANSMIT GAIN)	20
7.1 Test Objectives.....	20
7.2 Principle.....	20
7.2.1 Power Balance	20
7.2.2 EIRP Calibration	20
7.2.3 Linearity of EIRP Indication.....	21

7.2.4	Transmit Gain	21
7.2.5	Maximum EIRP Capability of SUT	22
7.3	Step-by-Step Procedure.....	22
7.4	Example for Spectrum Analyser Settings	24
8	TRANSMIT POLARIZATION DISCRIMINATION	25
8.1	Objectives.....	25
8.2	Principle.....	25
8.3	Step-by-Step Procedure.....	28
8.4	Example for Spectrum Analyser Settings	29
9	TRANSMIT SIDELOBES	31
9.1	Test Objectives.....	31
9.2	Principle.....	31
9.2.1	General.....	31
9.3	Step-by-Step Procedure.....	33
9.4	Example for Spectrum Analyser Settings	36
10	G/T	37
10.1	Test Objectives.....	37
10.2	Principle.....	37
10.3	Step-by-Step Procedure.....	39
10.4	Example for Spectrum Analyser Settings	40
11	RECEIVE POLARIZATION DISCRIMINATION	43
11.1	Test Objectives.....	43
11.2	Principle.....	43
11.3	Step-by-Step Procedure.....	45
11.4	Example for Spectrum Analyser Settings	46
12	RECEIVE SIDELOBES (INCLUDING RECEIVE GAIN)	48
12.1	Test Objectives.....	48
12.2	Principle.....	48
12.2.1	Antenna Pattern	48
12.2.2	Receive Gain	48
12.3	Step-by-Step Procedure.....	50
12.4	Example of Spectrum Analyser Settings	51
Annex A - Questionnaire		52
Annex B - List of Abbreviations.....		24
Annex C - Measurement of Spurious Radiation		25

C.1 Test Objectives..... 25

C.2 Principle 25

C.3. Summary of Requirements 25

C.4. Test conditions..... 26

C.5. Potential Pitfalls..... 26

C.6. Step by Step Procedure 27

C.7. Spectrum Analyser Settings 28

FOREWORD

The Eutelsat S.A. Systems Operations Guide (ESOG) is published to provide all Eutelsat S.A. space segment users with information that is necessary for successful operation of earth stations within the Eutelsat S.A. satellite system.

The ESOG consists of 2 Volumes. They contain, in modularised form, all the necessary details, which are considered important for the operations of earth stations.

Volume I focus on Earth Station and Antenna Approvals, System Management and Policy aspects.

Volume II describes the initial line-up of satellite links between earth stations and the commissioning of earth stations for Eutelsat S.A. services. The modules which are contained in this Volume relate to the services provided via Eutelsat S.A. satellites.

The ESOG can be obtained either by requesting a printed version from Eutelsat S.A. or by downloading it in PDF from the Eutelsat S.A. Website:

<http://www.Eutelsat.com/en/support/earth-stations/esog.htm>

1 OVERVIEW ESOG MODULES

1.1 VOLUME I: Eutelsat S.A. SYSTEM MANAGEMENT AND POLICIES

Earth Station Standards	Module 100
Earth Station Access and Approval Procedures	Module 110
Earth Station Type Approval	Module 120
Earth Station Verification Assistance (ESVA)	Module 130
Operational Management, Control, Monitoring & Coordination	Module 140
VSATs' ODU Type Approval	Module 160

1.2 VOLUME II: Eutelsat S.A. SYSTEMS OPERATIONS AND PROCEDURES

Digital Services Handbook	Module 210
VSAT Handbook	Module 230
Manual and auto-deploy terminals Handbook	Module 260

2 INTRODUCTION

Eutelsat S.A approval procedures require the submission of technical earth station data to demonstrate compliance with the relevant specifications (ESOG Vol. I, Module 100 and Module 110 refer).

In general, this can be achieved by the following means:

- Eutelsat ESVA facilities
- Facilities agreed by Eutelsat such as:
 - far field test ranges, compact ranges, near field ranges, etc.
 - other satellite systems
- Some combination of these facilities

The purpose of conducting verification tests is to prove that the earth station and/or associated equipment will comply in all respects with the mandatory performance characteristics as set forth in the relevant specifications.

Verification testing involving the use of a Eutelsat satellite shall be conducted in coordination with the Eutelsat ESVA team and/or a qualified corresponding earth station.

ESVA testing may be required upon request from Eutelsat or the earth station owner. The ESVA testing may generally be required:

- for new earth stations prior to commencement of service.
- for existing earth stations after major modifications (especially of the RF front end).

Typical parameters which can be measured using a Eutelsat satellite and are included in the standard program presented in this Module are:

- earth station EIRP
- transmit gain
- transmit sidelobes
- transmit polarisation isolation
- receive gain
- G/T
- receive polarisation isolation
- receive sidelobe patterns

The above measurements are generally conducted between a Eutelsat Reference Station (ERS) and a Station Under Test (SUT) via the Eutelsat space segment. This enables testing of a given station at its true, operational configuration. For small earth stations (aperture <2 m), such as VSAT or SNG terminals, which are furnished with manual antenna pointing, the pattern measurements may be very time consuming and inaccurate if conducted from a remote site. Such stations may therefore be more conveniently Type Approved or Characterised following ESOG 120 guidelines.

3 ESVA REQUIREMENTS

This section includes the conditions which ensure smooth implementation of ESVA, namely:

- prevention of interference to existing traffic,
- consistency of measurement results,
- efficient coordination of testing.

The rules given hereafter apply to **all** ESVA activities including full scale ESVA programmes or parts of it and repetitions.

3.1 Earth Station Preparation

The correct function of all relevant earth station equipment must be verified by preliminary in-station testing in order to avoid delay of ESVA and interference to existing traffic during the initial space segment access. As far as possible, the in-station test shall prove compliance of the equipment with the Eutelsat specification. Additional parameters which are required for ESVA such as:

- antenna slew speed for azimuth and elevation,
- power meter coupling factor and post coupler loss for each TX chain,
- receive coupling factor and receive feed loss if applicable

shall be measured during the preparational phase and results shall be communicated to Eutelsat.

Before the commencement of the ESVA, the SUT must be already configured for the forthcoming measurements as shown in Figure 5.1. The station shall acquire and track the satellite foreseen for testing and the equipment shall be set to parameters defined in the Eutelsat test plan.

To eliminate eventual problems at this stage, it is strongly recommended to perform a G/T and a receive sidelobe pattern test, using the satellite beacon.

3.2 Test Coordination

Planning of ESVA activities is based on the initial ES registration sent by the applicant responsible for the ES operations to the ES approval Office of Eutelsat:

1. online through the Eutelsat extranet portal (<https://services-cas.eutelsat.fr/cas/login>) or
2. by mail at esapproval@eutelsat.com, by completion of the procedures reported in the ESOG Module 110, and the form reported in its Annex A. The form may be used for already approved stations.

The completion of the ESVA questionnaire reported in Annex B is then required in preparation for the ESVA.

An advance notice of normally 2 weeks prior to the tentative ESVA date, should be given to ensure smooth implementation. Eutelsat issues a test plan which includes the confirmation of the availability of the ESVA facility (i.e. space segment and reference station). It must be born in mind that, due to operational needs, the test plan may be subject to changes at any time on short notice. The test plan contains the time schedule, technical and geographical parameters, contact points and notes required for preparation and execution of the subject test.

Immediately after conclusion of testing, the ERS operator forwards to the applicant a provisional test report to the test manager of the SUT. Nevertheless, all data is subject to confirmation by

Eutelsat who will issue the final test report with the conclusions usually within 4 weeks. In case of heavy non-compliances, a summary report is delivered faster to allow discussions between the responsible of the ES and the Eutelsat Approval Office.

This final report comprises results and parameters in detail and, will be forwarded to the applicant for ESVA.

3.3 Space Segment Access

Prior to commencement of any test programme, the Station Under Test (SUT) must contact the Eutelsat Reference Station (ERS). The contact of the ERS operator is provided by Eutelsat ES approval team. The reference station will then coordinate with the Eutelsat CSC the forthcoming test activities. The reference station must obtain the approval of the CSC for space segment access before the start of testing and report to the CSC when testing is terminated or in case of significant interruptions.

Note: the ERS operator shall double check with the CSC the exact nominal uplink EIRP before starting any transmission.

Furthermore, each space segment access by a station under test must be endorsed by the ERS. When transmitting, the SUT must maintain contact with the reference station at all times. In particular, the SUT must ensure permanent presence of staff at the phone to guarantee instant reaction on ERS directives. If the communication link fails, the Station Under Test must immediately cease transmissions and attempt to re-establish contact with the reference station. It is therefore essential that suitable telephone equipment is available and accessible at all relevant sites (e.g.: antenna hub, control room etc.) throughout the testing.

If other means of communication are preferred by the SUT, e.g. videoconferencing tools, they must be agreed with the ERS in advance and tested before the ESVA begin to ensure the respect of the test schedule. The detailed procedures compulsory to each space segment access are prescribed in paragraph 4.1 of this document.

3.4 Weather Conditions

Atmospheric attenuation and wind may considerably degrade the accuracy of measurements. It is therefore preferable to conduct ESVA testing during clear sky conditions with light wind-speeds. If, due to operational needs, testing must be performed during deteriorated weather conditions, special consideration will be given during results evaluation. In case of discrepancies, partial or complete repetition of the test programme will be agreed.

3.5 Antenna Alignment

All ESVA tests are based on the perfect initial alignment of the antenna under test. Great care must be taken by the SUT when optimizing the antenna pointing, i.e. peaking.

Peaking must be performed initially, i.e. prior to testing,

1. after each antenna movement (e.g. during G/T, antenna sidelobe measurements etc...),
2. after interruption of the test programme.

The SUT must ensure that optimized pointing is achieved before all measurements. On request, the ERS will provide assistance and guide the SUT.

3.6 Check List

Completion of the following checklist by the SUT, before the start of an ESVA activity will prevent delays.

- Earth Station equipment functions compliant to specifications:
 - Antenna, drive and tracking system,
 - HPA,
 - LNA (LNB, LNC),
 - Up and Down-Converters,
 - Station control and waveguide switching,
 - TX chains have been checked for spurious emissions;
- Test equipment is available, calibrated and warm-up period respected:
 - RF synthesizer (frequency drift measured),
 - RF power meter (auto-zero, calibration factor set),
 - Spectrum Analyser (calibration procedure completed),
 - Plotter (connected, calibrated);
- TX power meter coupling factors and post coupler losses measured for each TX-chain, results sent to Eutelsat;
- Satellite as per test plan acquired, antenna pointing optimized (peaking);
- Polarization alignment optimized;
- Appropriate means for communication during the test are available;
- [optional] G/T and antenna RX-pattern;

4 TEST EQUIPMENT

The measurement equipment which must be available at the SUT during ESVA, is summarized hereafter. The lack of measurement equipment could lead to incomplete results. Prior to the start of ESVA, the station operator shall ensure that all test equipment:

- functions correctly,
- warm-up periods are respected,
- calibration procedures and timing have been respected.

For completion of test records, the test equipment types shall be reported to Eutelsat.

4.1 RF Power Meter

The RF power meter is required for the measurement of the transmit power and calibration of the station EIRP. At SUT equipped for pilot injection, the power meter is furthermore required for measurement of the pilot level. Generally, the dynamic range of the power sensor should be dimensioned to include the full range of transmit power required during operations and ESVA. Before measurements, the operator shall set the appropriate calibration factor and execute an "Auto-Zero" cycle to ensure accurate results.

4.2 RF Spectrum Analyser

The spectrum analyser is required for execution of the space segment access test, the measurement of the G/T ratio and the antenna receive sidelobe pattern. Furthermore, it is used for monitoring of the receive frequency range and the HPA output. To facilitate the G/T measurement, it is preferable to use an analyser which permits a direct noise level readout (noise marker) in dBm/Hz. Both RF and IF frequency bands of the SUT should be covered by the analyser.

The spectrum analyser shall have the possibility to store the captured spectrum and measurement into digital files that will be exported and shared with Eutelsat.

4.3 Signal Source

For the assessment of transmit parameters, a stable signal source is required at the station under test. To prevent interference when testing is conducted via transponders bearing traffic, to obtain a maximum dynamic range and accuracy, the frequency drift, residual modulation and level variation must be kept at a minimum.

The short-term frequency drift measured at RF level (e.g. 14 GHz), should be less than 10 Hz per 30 minutes (typical figure: 5×10^{-10} /day ageing rate). Therefore, a synthesized source is required for generation of the test signal. Alternatives like the operational modulator (preferably with clock locked to an external high stability reference) require prior endorsement by Eutelsat and should be considered only in exceptional case.

4.4 Temporary Approval or Modification of an Existing Authorisation to Operate

Earth stations are sometimes used to enable operators to utilise satellites for unforeseen ad-hoc events, requiring urgent access to the space segment.

Eutelsat S.A. may extend or modify an existing authorisation for operation at a different location, or to grant temporary approval for the provision of commercial service of an ad-hoc nature (e.g. Emergency Telecommunication Services) for a single short duration purpose and within established Eutelsat S.A. policies.

5 SPACE SEGMENT ACCESS TEST

5.1 Test Objectives

1. Ensure the correct alignment with parameters set by the Eutelsat test plan.
2. Prevent any interference to existing services.
3. Evaluate basic carrier parameters as frequency drift and EIRP fluctuation in order to estimate possible impairments to test results and to adapt instrument settings at ERS accordingly.

5.2 Principle

Initially, the ERS transmits a marker carrier which shall be identified by the SUT to prove correct pointing. Upon authorization by the ERS, the SUT transmits at low EIRP. The ERS will check value and fluctuation of carrier level and frequency.

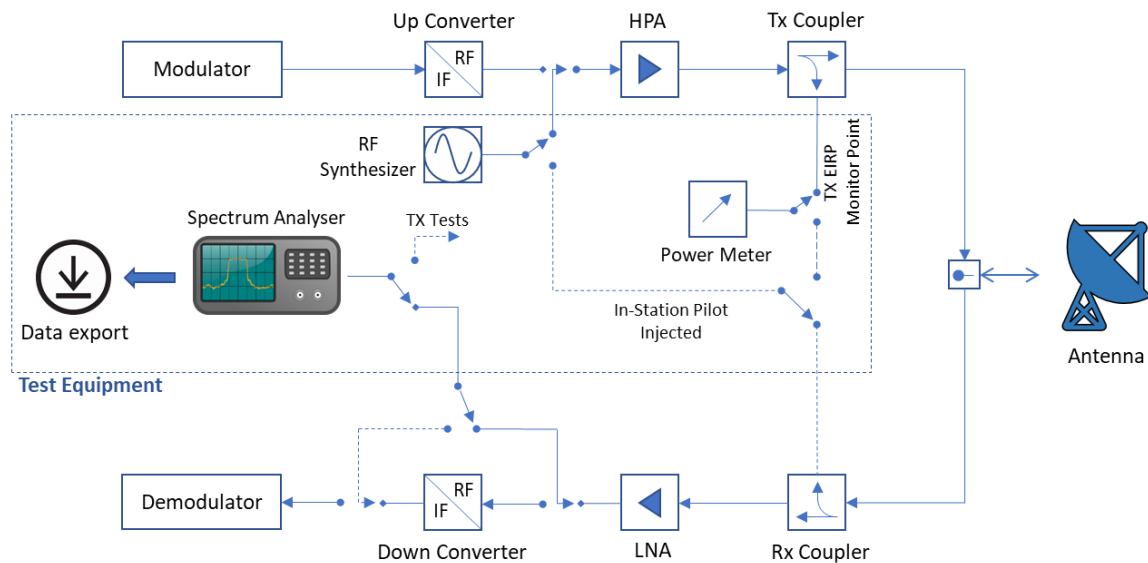

Figure 5.1: SUT Configuration during ESVA.

5.3 Step-by-Step Procedure

A. ACQUISITION OF SATELLITE

Step 1: Upon successful completion of the independent in-station tests as described under Section 3.1 above and **PRIOR** to the transmission of **ANY** signal, the SUT shall identify, acquire and track the specified satellite.

Step 2: SUT set the polarization angle according to the parameter provided in the Eutelsat test plan. For further optimization, SUT shall monitor the cross-polar component of the satellite beacon signal. The SUT shall slowly rotate the polarization plane until the level reaches a minimum.

NOTE: Where this procedure is not applicable (e.g. for transmission on X polarization from SUT equipped with a 2-port feed), another suitable signal on the satellite may be used.

B. ACCESS COORDINATION

Step 3: Immediately prior to the scheduled commencement of ESVA (i.e. ~ 5 minutes) the SUT shall establish and maintain phone contact with ERS. SUT shall communicate sky and wind conditions and information on all details which may impair testing.

Step 4: ERS shall contact the Eutelsat CSC to obtain authorization for space segment access and confirmation of the nominal uplink EIRP to be used during the tests

Step 5: In accordance with parameters of the Eutelsat test plan, ERS transmit a marker carrier.

Step 6: On request of ERS, SUT monitor the allocated down-link frequency range. SUT reconfirm presence of the marker carrier to ERS.

Step 7: ERS double-checks identification of marker carrier by SUT. Proceed to Step 9 only if identification is affirmative.

C. TRANSMISSION BY SUT

Step 8: Under direction of the ERS, SUT transmit a carrier at the assigned frequency and EIRP. (The initial EIRP is in general in the order of 50 dBW and it must never exceed 55 dBW).

NOTE: The SUT must **CEASE** transmissions immediately if the communications link to the ERS fails or if the presence of staff at the SUT phone is interrupted. This rule applies to this and all following tests where the SUT transmits.

Step 9: SUT notify the ERS of the activation of its carrier.

Step 10: If the ERS does not detect the carrier under test within the allocated frequency range, the SUT shall CEASE transmissions. The SUT shall again verify its set-up on:

- correct satellite acquisition,
- polarization plane alignment,
- transmit frequency and
- transmit EIRP

and return to Step 8.

Step 11: SUT monitor the receive level of its own transmitted carrier. ERS request SUT to slew SUT antenna first in azimuth and then in elevation to reconfirm correct pointing.

Step 12: SUT report TX power meter reading to ERS and maintain frequency setting throughout following tests.

5.4 Example for Spectrum Analyser Setting

Reference level	: As applicable
Attenuator	: As applicable
Scale	: 1 dB/Division
Centre frequency	: SUT down-link frequency as per
	: test plan (11 or 12 GHz range)
Span	: 200 Hz
Resolution bandwidth	: Auto
Video bandwidth	: Auto
Video averaging	: OFF
Sweep time	: Auto
Marker noise	: OFF
D-Marker	: OFF
Trace	: Clear write A
	: Max. Hold BDisplay line : OFF

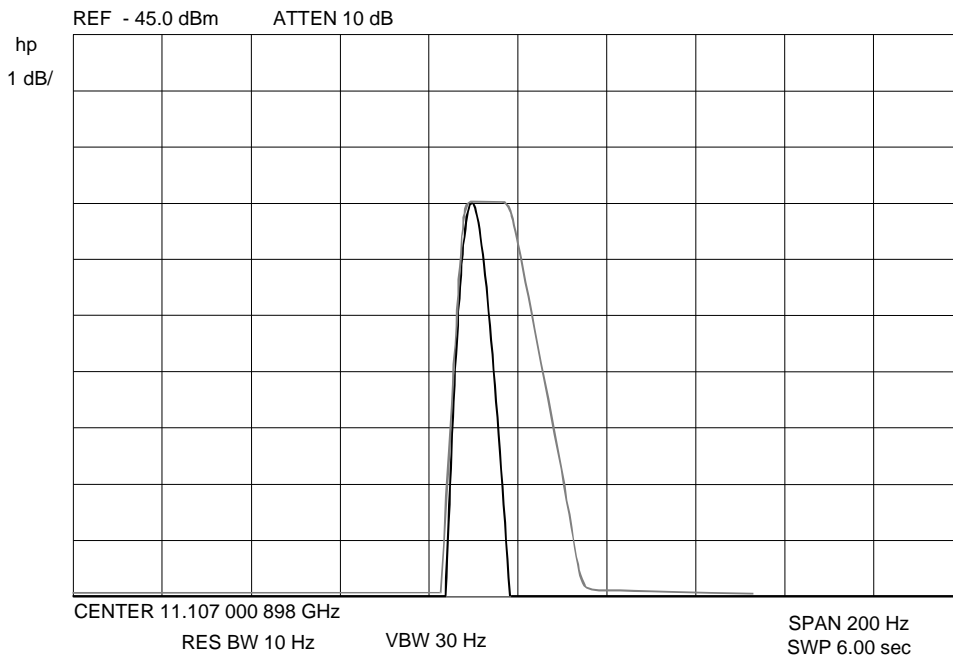

Figure 5.2: Spectrum Analyser Display at ERS during Space Segment Access Test (Verification of frequency stability).

6 POLARIZATION ALIGNMENT

6.1 Test Objectives

To accomplish optimum alignment of the polarization plane of the SUT antenna with the receive antenna of the satellite, in order to guarantee accurate ESVA measurement results.

For SUT equipped with 4-port feed, to evaluate isolation of transmit polarization planes (X and Y for linear polarization or LH and RH for circular polarization).

6.2 Principle

The SUT transmits a carrier via the co-polar channel while the ERS monitors the residual carrier level in the cross-polar channel. Under control of the ERS, the SUT slowly rotates its polarization plane. The ERS records the variation of the cross-polar level and guides the SUT to the angular position where the minimum level is detected (nulling).

The following configurations must be considered:

1. the down-link frequency bands of the co-polar and cross-polar channel are different.
2. the co-polar channel is set to minimum gain and the cross-polar channel is set to maximum gain

For SUT equipped with a 4-port feed, and in order to verify the isolation of the polarization planes, the alignment procedure is executed via both polarizations (X and Y, LH and RH). For linear polarizations, the angle indications for the optimum positions are read for X and Y polarization and then compared.

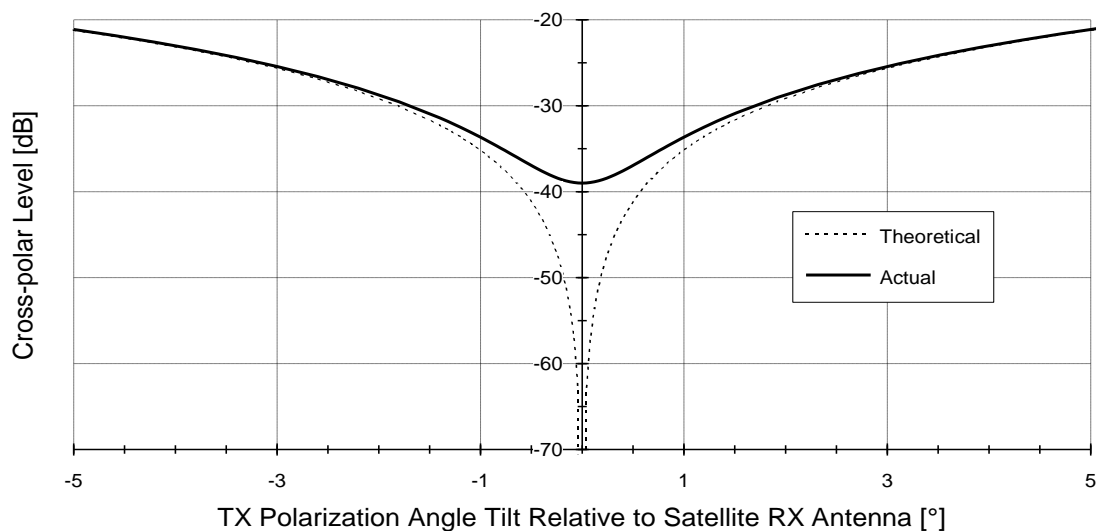

Figure 6.1: Cross-polar Signal Level as Function of Polarization Plane Alignment.

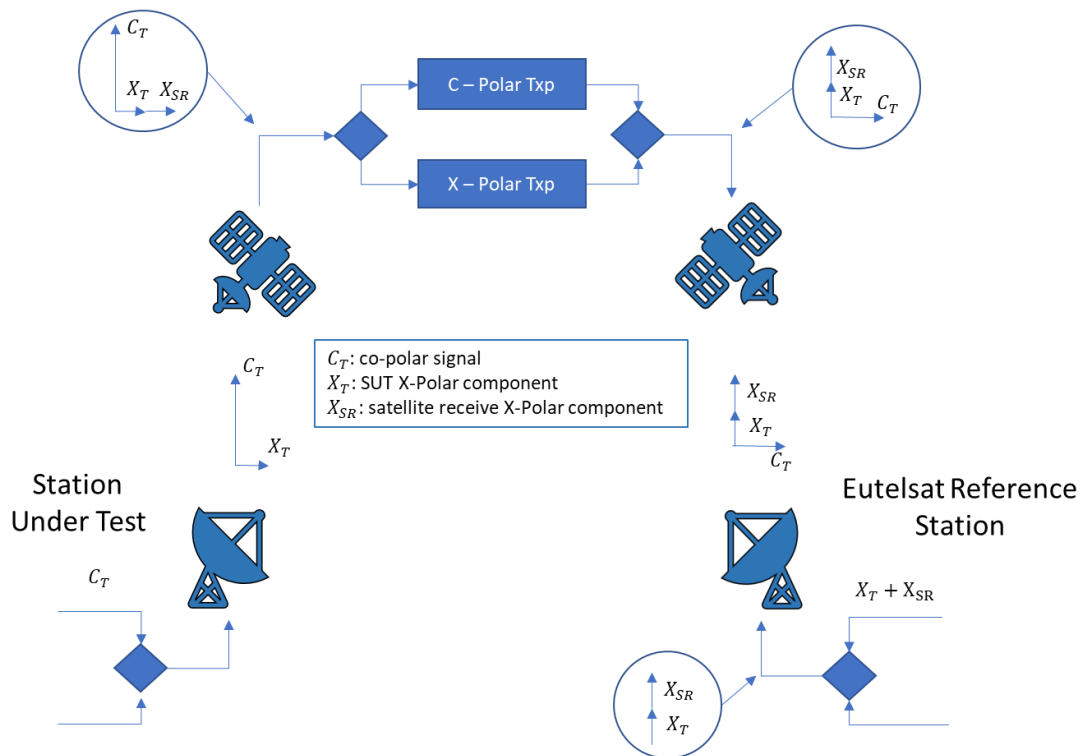

Figure 6.2: Schematic Representation of Polarization Alignment for linear polarization.

6.3 Step-by-Step Procedure

[Linear and circular polarizations]

- Step 1: SUT set antenna tracking system to manual mode.
- Step 2: Under direction of ERS, SUT transmit a carrier at the frequency as established during the Satellite Access Test and set the EIRP as per test plan.
- Step 3: ERS record the level of the cross-polar component of the carrier under test.

[Linear polarization only]

- Step 4: In coordination with the ERS, SUT rotate slowly the polarization plane in the following way:
 1. Rotate towards the anti-clockwise limit. (e.g.: -5° relative to start position).
 2. Rotate via the optimum to the clockwise limit. (e.g.: $+5^\circ$ relative to start position).

NOTE: Values of angles are positive if the rotation is clockwise as seen from the earth station towards the satellite.

- Step 5: ERS guide SUT to acquire the optimum position (i.e. where polarization plane of SUT and satellite receive antenna match and a minimum in cross-polar level is observed).
- Step 6: SUT secure feed position. ERS verify that the optimum is maintained.
- Step 7: SUT report the polarization angle indication to the ERS. If the SUT is not equipped with indicators, the feed position shall be marked.

6.4 Example for Spectrum Analyser Setting

Reference level:	: As applicable
Attenuator:	: As applicable
Scale:	: 5 dB/Division
Centre frequency:	: SUT down-link frequency as per test plan (11 or 12 GHz range)
Span:	: 0 Hz
Resolution bandwidth:	: 100 Hz
Video bandwidth:	: 3 Hz
Sweep time:	: 100 s or a appropriate
Marker noise:	: OFF
Δ-Marker:	: Disabled
Trace:	: Clear write ADisplay line: : Set to minimum

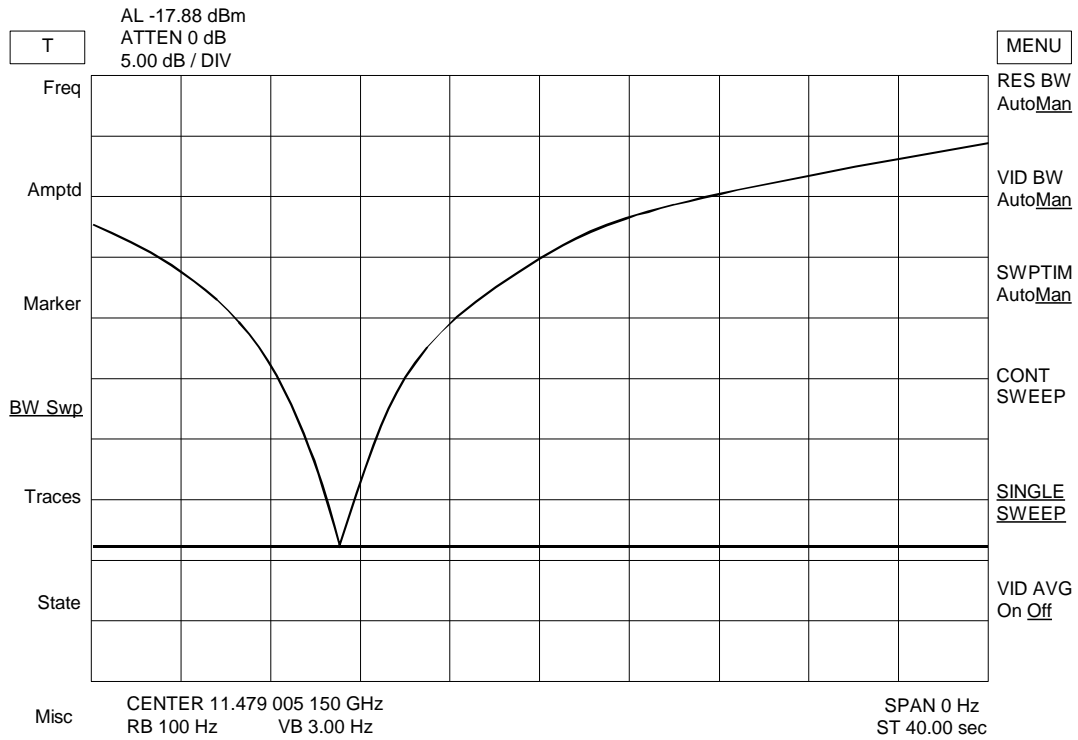

Figure 6.3: Spectrum Analyser Display during Polarization Plane Alignment.

7 EIRP (INCLUDING TRANSMIT GAIN)

7.1 Test Objectives

1. Reconfirm the SUT EIRP calibration prior to commencement of operations,
2. Assess the linearity of the EIRP indication at the SUT,
3. Evaluate the transmit gain of the antenna at the SUT,
4. Measure the maximum EIRP capability of the SUT.

7.2 Principle

7.2.1 Power Balance

The EIRP measurement is based on the up-link power balance technique where the EIRP of the SUT is compared against an accurately calibrated EIRP radiated from the ERS. Corrections for the satellite antenna receive gain (off-axis loss), path loss and atmospheric loss due to the distant location of both stations are applied to obtain the value of the SUT EIRP. To minimize the influence of amplitude-frequency response of the satellite transponder and ERS, the difference of carrier frequencies of SUT and ERS is small (generally < 100 kHz). Carrier levels of both SUT and ERS are equal or differ by no more than 0.2 dB to avoid inaccuracies due to the non-linearity of the satellite TWT.

The following formula applies:

$$\begin{aligned}
 EIRP_{SUT} = EIRP_{ERS} &+ (L_{oa,SUT} - L_{oa,ERS}) \\
 &+ (L_{at,SUT} - L_{at,ERS}) \\
 &+ (L_{fs,SUT} - L_{fs,ERS}) - \Delta
 \end{aligned}
 \tag{Equation 7-1}$$

where:	L_{oa} : Off-axis Loss	[dB]
	L_{fs} : Free space Loss	[dB]
	L_{at} : Atmospheric Loss	[dB]
	Δ : Small difference between EIRP of carriers	[dB]

Δ is positive when: $EIRP_{SUT} < EIRP_{ERS}$

Δ is small when: $|\Delta| < 0.2 \text{ dB}$

L_{at} is measured at the ERS by radiometer during the test. For SUT where no radiometer is available, 0.3 dB shall be assumed for clear sky conditions.

The values of free-space loss (L_{fs}) and off-axis loss (L_{oa}) will be indicated in the relevant Eutelsat test plan.

7.2.2 EIRP Calibration

At power balance condition, the SUT reads the transmit power meter. This value which corresponds to a (now) accurately known EIRP, shall be noted and used as reference for future operations.

In cases where the power reading during operations will not be derived from the same test point, it is essential to include the operational test point in the calibration procedure.

7.2.3 Linearity of EIRP Indication

EIRP calibration is repeated at several (e.g. 4) different EIRP levels. The range shall include the future operational EIRP of the SUT. It shall thus provide a reliable base for determination of any EIRP value required during forthcoming SUT operations

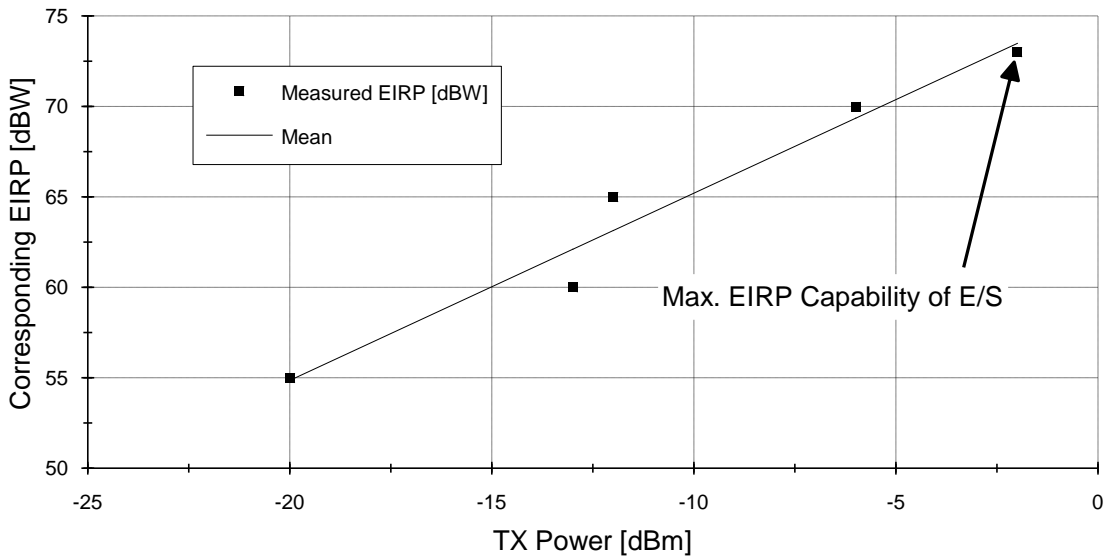

Figure 7.1: Linearity of TX Power Indication.

7.2.4 Transmit Gain

At known station EIRP the antenna Transmit gain of the SUT may be calculated. During ESVA preparation, transmit power meter coupling factor and loss between transmit coupler and antenna flange (or interface where antenna gain is defined) have to be obtained by in-station measurements.

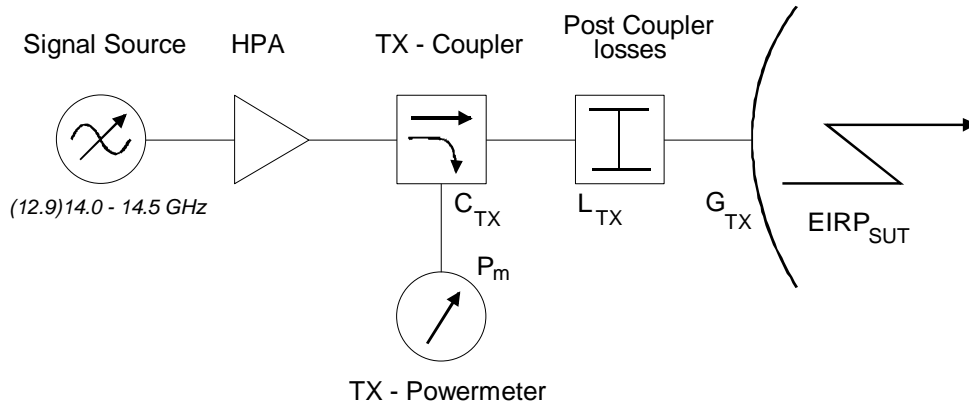

Figure 7.2: Schematic Diagram of SUT TX-Chain.

Using the value of $EIRP_{SUT}$ from Equation 7-1 above, the TX gain is given by:

$$G_{TX} = EIRP_{SUT} - P_m + 30 - C_{TX} + L_{TX} \tag{Equation 7-2}$$

where:

- P_m : Transmit power meter reading [dBm]
- C_{TX} : Transmit coupling factor [dB]
- L_{TX} : Post coupler Losses [dB]
- 30 : Conversion dBW => dBm [dB]

To appreciate the measurement result, it is compared to the expected value which may be computed as follows:

$$G = 10 \log_{10} \left[\eta \cdot a \cdot b \cdot \left(\frac{\pi \cdot f}{c} \right)^2 \right] \tag{Equation 7-3}$$

- where: G : Antenna gain [dBi]
- η : Efficiency (assumed at 0.65) [1]
- a, b : Major, minor axis of antenna reflector aperture [m]
- f : Frequency [Hz]
- c : Speed of Light (i.e. $\sim 3 \times 10^8$) [m/s]

7.2.5 Maximum EIRP Capability of SUT

Under close control of the ERS, the SUT increases its TX EIRP to the maximum value defined as per test plan or until the saturation of the SUT HPA, whichever is reached first. If applicable, 2 HPAs and phase combiner shall be used during this test. The ERS conducts a power balance and logs the maximum EIRP capability of the SUT as reference for Eutelsat records.

7.3 Step-by-Step Procedure

A. PREPARATION

Step 1: SUT forward the following information to Eutelsat prior to commencement of ESVA:

- Type of feed (2-port, 4-port),
- No of TX-chains,
- Coupling factor (C_{TX}) for each TX chain,
- Post coupling Loss (L_{TX}) for each TX chain.

B. POWER BALANCE

- Step 2: ERS transmits the reference carrier at the frequency and EIRP as specified by the ESVA test plan.
- Step 3: SUT adjust the EIRP setting to obtain the value specified in the ESVA test plan. Under the direction of the ERS, SUT commence transmission at the frequency established during the Satellite Access Test.
- Step 5: If necessary, SUT adjust the EIRP under control of ERS to balance the reference carrier. The difference in level of both carriers as monitored by the ERS shall not exceed 0.2 dB.
- Step 6: ERS confirm balance condition.
- Step 7: SUT read the TX power meter and report the value to ERS.

C. LINEARITY

- Step 8: If required by the test plan, ERS increase the EIRP of the reference carrier. Under control of ERS, SUT increase the EIRP of the carrier under test.
- Step 9: Repeat Steps 5 through 7 for each EIRP level to be calibrated.

NOTE: In general, the EIRP calibration is performed for the following levels:

1. Start EIRP.
2. Start EIRP – 5 dB.
3. Start EIRP – 10 dB.
4. Start EIRP – 15 dB.

The start EIRP is specified in the ESVA test plan.

D. MAXIMUM EIRP CAPABILITY

- Step 10: Carry out this step only if required by the ESVA test plan, otherwise proceed to Step 12.
- Step 11: Under close control of the ERS, SUT increase slowly the EIRP. The increase shall in no case exceed the limits given in the ESVA test plan to avoid interference to traffic or over saturation of the transponder. Below the specified limits, the SUT EIRP may be increased until the SUT HPA or, in case of phase combiner, the two SUT HPAs are saturated. SUT report the TX power reading to ERS. If the SUT Tx chain is equipped with several couplers, the calibration is performed using the coupler which is the nearest to the antenna feed. For cross-reference, at least 1 measurement shall be performed for each Tx chain using another coupler(s) (e.g. HPA RF power meter).
- Step 12: If the SUT EIRP capability is superior to the limit stated as per test plan, the ERS will request to commute the SUT TX-chain to dummy load and/or to de-point the SUT antenna far off the geostationary arc. Then, the SUT increases its power to its maximum. The corresponding power meter reading is communicated to the ERS, which will compute the maximum SUT EIRP capability. The SUT reduces its EIRP to the nominal level and ceases transmissions. To proceed with testing, the SUT re-acquires the satellite as previously defined.

Step 13: From the results of the previous power balance, ERS evaluate the maximum EIRP capability of the SUT and the SUT antenna TX gain, and if available, other power indications (e.g. output-power display of HPA).

7.4 Example for Spectrum Analyser Settings

Reference level	: As applicable
Attenuator	: As applicable
Scale	: 1 dB/Division
Centre frequency	: SUT down-link frequency as per test plan (11 or 12 GHz range)
Span	: 200 kHz
Resolution bandwidth	: 30 kHz
Video bandwidth	: Auto
Video average	: 20
Sweep time	: Auto
Marker noise	: OFF
Marker	: Peak search
Δ-Marker	: Δ-peak search
Trace	: Clear write A
Display line	: OFF

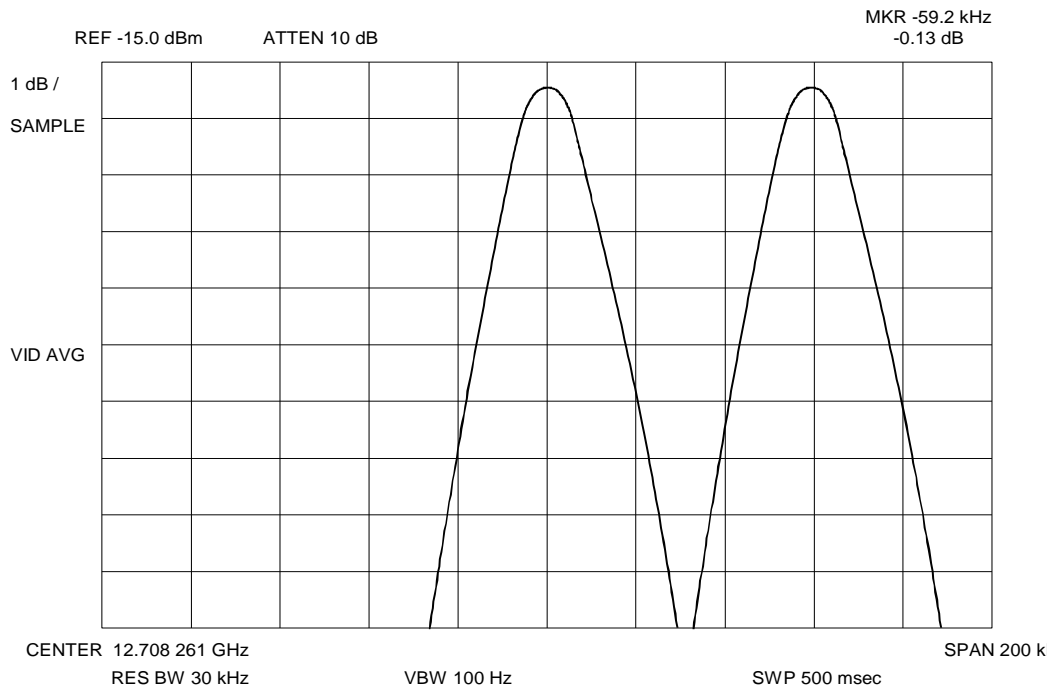

Figure 7.3: Spectrum Analyser Display during Power Balance.

8 TRANSMIT POLARIZATION DISCRIMINATION

8.1 Objectives

To measure the transmit polarization isolation of the Station Under Test at optimized TX polarization alignment. The measurement is carried out at boresight and at 8 samples within the 1 dB contour of the co-polar antenna TX pattern.

8.2 Principle

To measure the EIRP of the SUT, a power balance is carried out via the co-polar channel. Then, the ERS transmits a reference carrier (e.g. 20, 30 or 40 dB below the co-polar level) via the cross-polar transponder. From the difference in level of the reference carrier and the cross-polar component of the carrier under test, the transmit XPD of the SUT is computed. Then in order to verify the performance within the co-polar -1 dB TX contour, the SUT antenna is depointed in azimuth and elevation as described in the figure below:

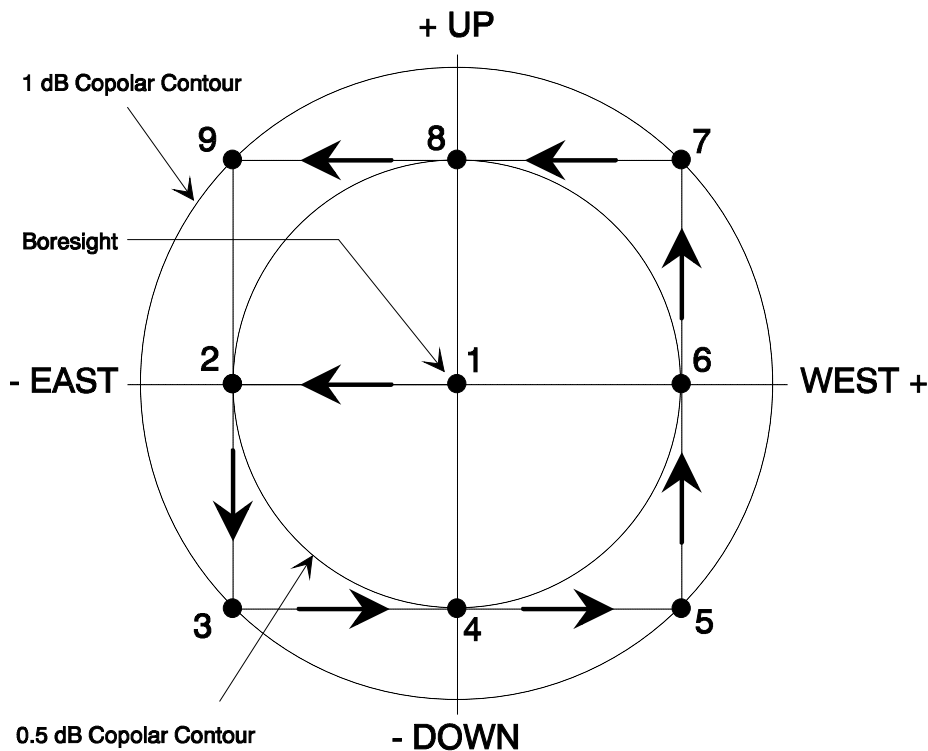

Figure 8.1: Antenna Depointing Sequence during XPD Measurements.

The angular increment for antennas with circular aperture may be estimated by the following expression:

$$AI = \frac{3.978}{d \cdot f} \tag{Equation 8-1}$$

where: d : Antenna diameter [m]
 f : Frequency [GHz]

(Ref.: CCIR Handbook on Satellite Communications).

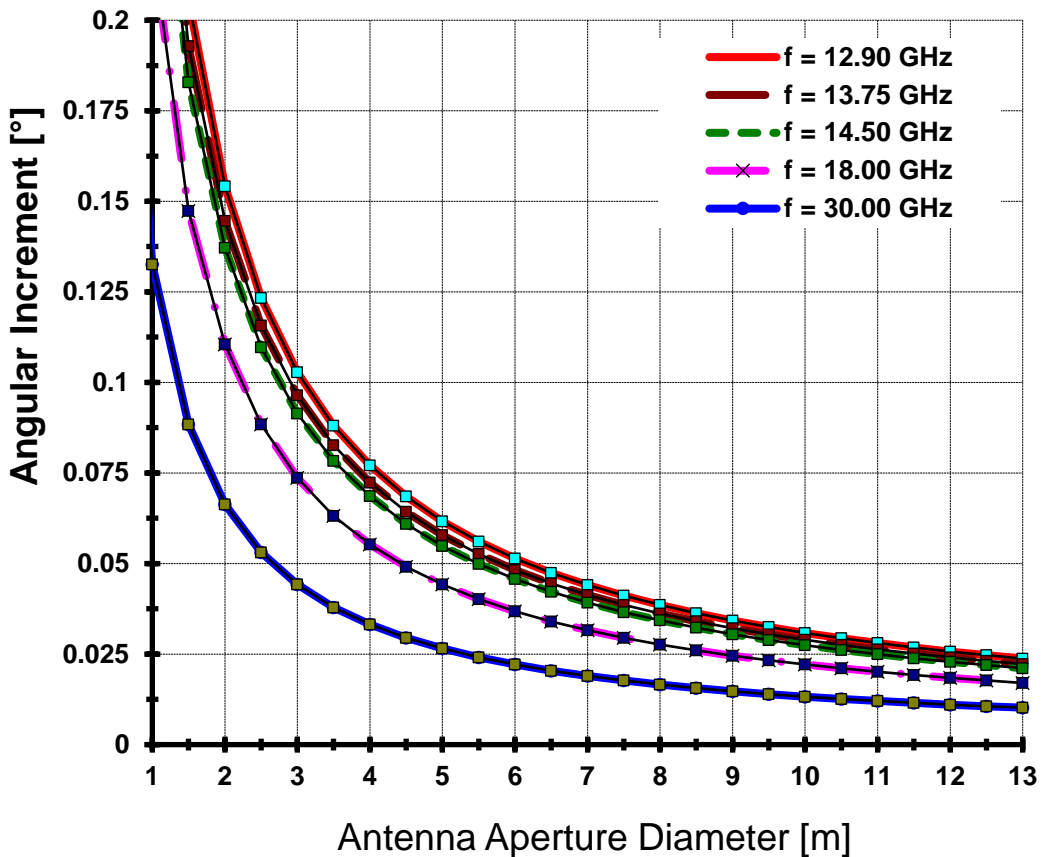

Figure 8.2: Angular Increment (AI) for TX-XPD Measurements.

While the SUT is depointing its antenna, the ERS monitors the variation of the co-polar carrier level and guides the SUT through the defined measurement pattern.

Nine measurements of the difference between the cross-polar component of the carrier under test and the cross-polar reference carrier are taken. Then the test configuration is reversed (i.e. the cross-polar channel becomes co-polar, etc...) and the measuring sequence is repeated. A correction for differences in the up-link off-axis loss between co-polar and cross-polar channel is applied and the XPD of the SUT is computed.

$$XPD = C_{SUT} - X_{SUT} \tag{Equation 8-2}$$

$$XPD = (C_{ERS} - X_{ERS}) - L_{OA,ERS,C} + L_{OA,ERS,X} + L_{OA,SUT,C} - D_C + D_X \quad \text{Equation 8-3}$$

Where:

- $(C_{ERS} - X_{ERS})$: Difference in EIRP of co-polar and cross-polar reference carrier [dB]
- D_C : Difference between co-polar reference carrier and co-polar carrier under test [dB]
- D_X : Difference between cross-polar reference carrier and cross-polar component of carrier under test [dB]
- L_{OA} : Off axis-Loss [dB]
- Index SUT: Station Under Test
- Index ERS: Eutelsat Reference Station
- Index C: Co-polar
- Index X: Cross-polar

NOTE: D_C, D_X is positive if the level of the reference is greater than the level of the signal under test.

In case of a perfect power balance via the co-polar channel (i.e. $D_C = 0$ at boresight), the values of D_C are as follows:

Point Nr.	D_C [dB]
1	0
2, 4, 6, 8	0.5
3, 5, 7, 9	1

Table 8.1: Variation of co-polar carrier level during depointing sequence.

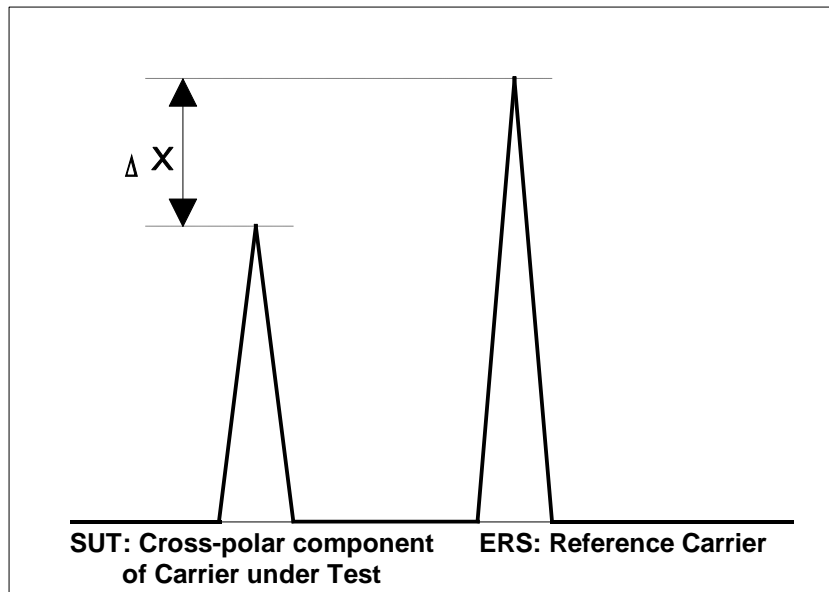

Figure 8.3: Carrier Configuration during XPD Measurements.

8.3 Step-by-Step Procedure

- Step 1: ERS transmit the reference carrier via the co-polar channel at the frequency and EIRP as specified in the Eutelsat test plan.
- Step 2: SUT adjust the EIRP setting to obtain the value specified in the Eutelsat test plan. Under direction of the ERS, SUT commence transmission at the frequency established during the satellite access test.
- Step 3: If necessary, SUT adjust the EIRP under control of ERS to balance the reference carrier.
- Step 4: ERS confirm balance condition.
- Step 5: ERS transmit the reference carrier via the cross-polar channel at EIRP (generally 20 to 40 dB below co-polar) and frequency as specified in the Eutelsat test plan. If needed carrier can be moved closer to test carrier.
- Step 7: ERS measure the difference in level between the reference carrier and the cross-polar component of the carrier under test. ERS compute the value of the TX-XPB of the SUT.
- Step 8: In coordination with the ERS, SUT move the antenna off-boresight according to Figure 8.1. The angular increment (AI) is given in the Eutelsat test plan. ERS monitor the variation of the co-polar level of the carrier under test. If necessary, guide the SUT to the required antenna positions.
- Step 9: Repeat Step 7.
- Step 10: Repeat Steps 8 and 9 for the remaining points.

8.4 Example for Spectrum Analyser Settings

Co-polar Signal:

Reference level	: As applicable
Attenuator	: As applicable
Scale	: 1 dB/Division
Centre frequency	: SUT down-link frequency as per test plan (11 or 12 GHz range)
Span	: 200 kHz
Resolution bandwidth	: 10 kHz
Video bandwidth	: 3 kHz
Video average	: ON (10 samples)
Sweep time	: Auto
Marker noise	: OFF
Δ-Marker	: ON (Marker peak search at boresight)
Trace	: Clear write A
Display line	: ON (Set to level at boresight)

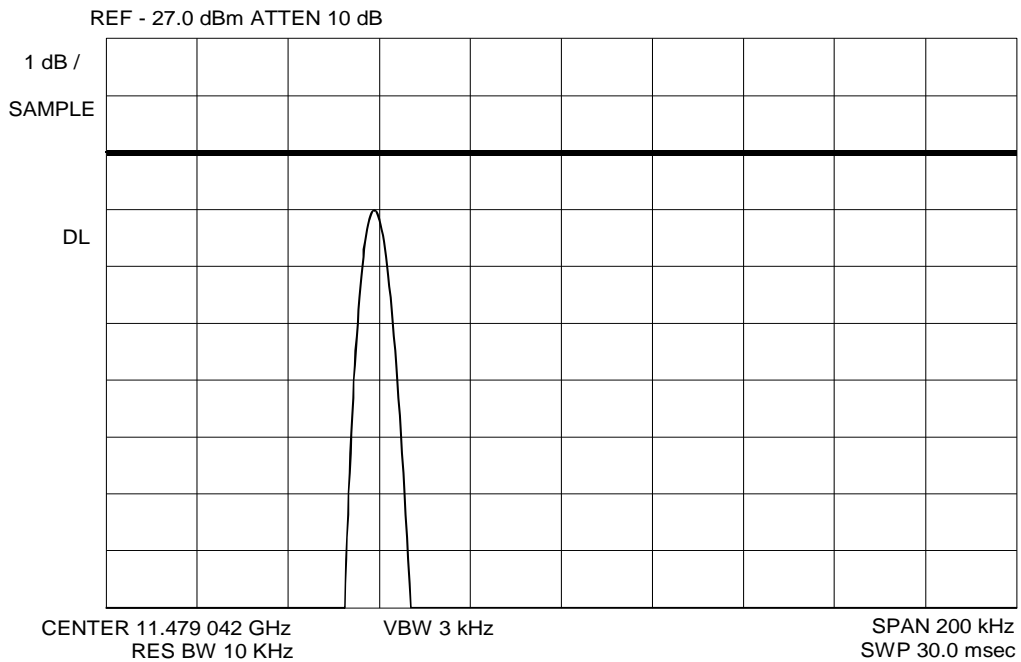

Figure 8.4: Spectrum Analyser Display during TX-XPD Measurement (Co-Polar Signal).

Cross-polar Signal:

Reference level	: As applicable
Attenuator	: As applicable
Scale	: 5 dB/Division
Centre frequency	: Centre between down-link frequencies of SUT and ERS (11 or 12 GHz range)
Span	: As applicable
Resolution bandwidth	: As applicable
Video bandwidth	: As applicable
Video average	: ON (10 samples)
Sweep time	: Auto
Marker noise	: OFF
Δ-Marker	: ON (Marker set to ERS carrier, Δ-Marker to SUT cross-polar signal)
Trace	: Clear write A
Display line	: OFF

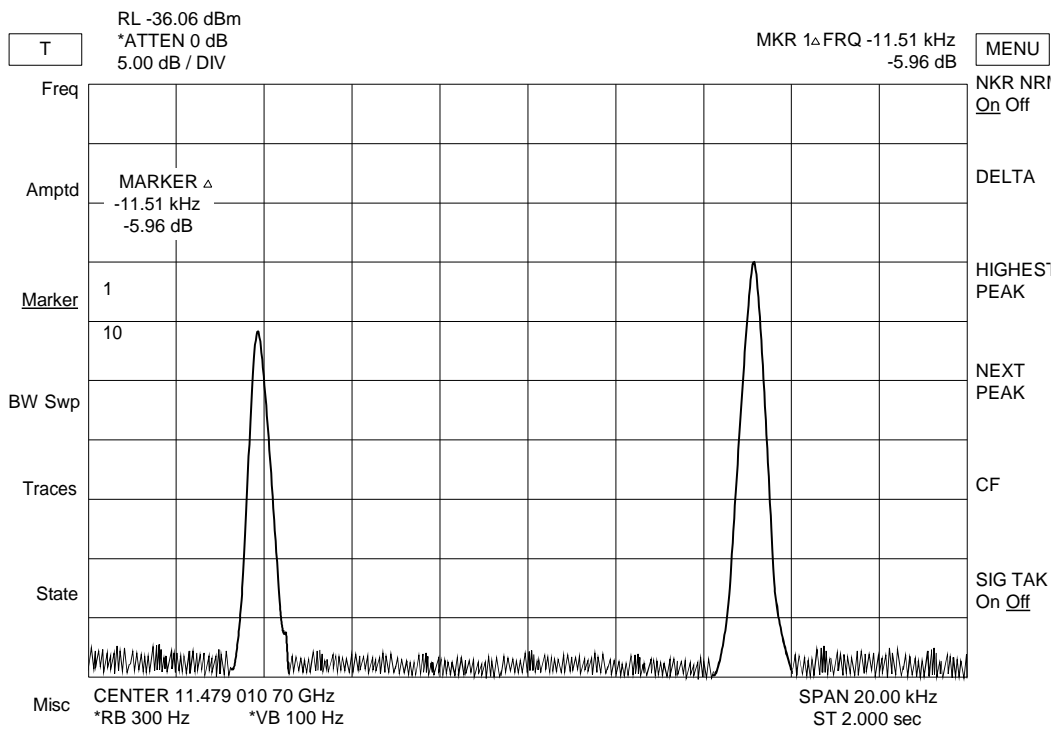

Figure 8.5: Spectrum Analyser Display during TX-XPD Measurement (Cross-Polar Signal).

9 TRANSMIT SIDELOBES

9.1 Test Objectives

To record the co- and cross-polar radiation diagrams of the antenna of the station under test, the result shall enable Eutelsat to determine the maximum permissible EIRP limits of the SUT.

9.2 Principle

9.2.1 General

While transmitting a carrier the SUT slews its antenna in azimuth or elevation and communicates continuously the antenna position readout to the ERS. The ERS records the level of the co- and cross-polar components of the received carrier. Prior to the antenna measurement, the ERS performs a calibration to compensate inaccuracies which may be caused by non-linearity of the satellite transponder or the ERS RX chain. The ERS processes angular information, calibration data and the recorded level to produce the antenna pattern. For azimuth cuts, the following correction is applied to compute the true angle from the azimuth readout.

$$\sin\left(\frac{Az'}{2}\right) = \sin\left(\frac{Az}{2}\right) \cdot \cos(El) \quad \text{Equation 9-1}$$

Where:

- Az' : Real angle from boresight.
- Az : Azimuth as read from encoders.
- El : Elevation under which the test is performed.

To facilitate the evaluation the following envelope is given in Figure 9.2.

Co-polar:

$$\begin{cases} 29 - 25 \cdot \log_{10}\theta & \text{dBi for } 1^\circ < \theta \leq 7^\circ \\ +8 & \text{dBi for } 7^\circ < \theta \leq 9.2^\circ \\ 32 - 25 \cdot \log_{10}\theta & \text{dBi for } 9.2^\circ < \theta \leq 48^\circ \\ -10 & \text{dBi for } 48^\circ < \theta \end{cases} \quad \text{Equation 9-2}$$

Cross-polar:

$$\begin{cases} 19 - 25 \cdot \log_{10}\theta & \text{dBi for } 1.8^\circ < \theta \leq 7^\circ \\ -2 & \text{dBi for } 7^\circ < \theta \leq 9.2^\circ \end{cases} \quad \text{Equation 9-3}$$

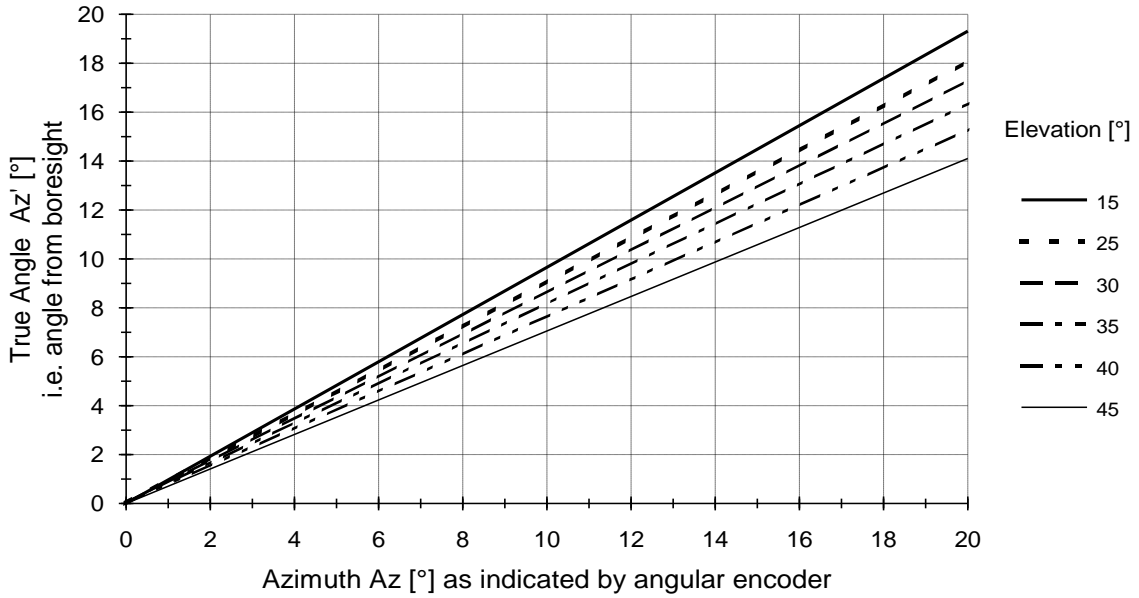

Figure 9.1: True Angle (Az') as Function of Azimuth (Az).

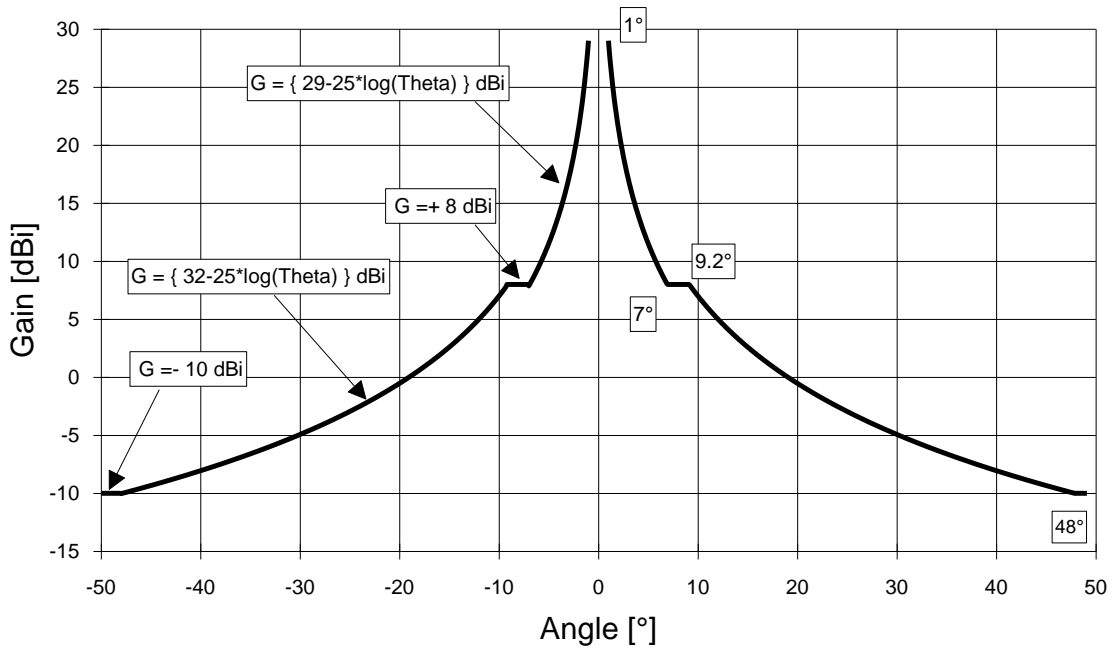

Figure 9.2: Envelope for Co-polar TX Sidelobe Pattern.

9.3 Step-by-Step Procedure

This procedure is applicable to earth stations equipped with motorized antenna drives.

A. PREPARATION

Step 1: During ESVA preparation, prior to commencement of testing, SUT investigate the slew speed for azimuth and elevation antenna movement and forward the values to Eutelsat. If various settings are available (e.g. SLOW and FAST), all speeds should be communicated to Eutelsat. If these parameters are not provided by the station manufacturer, the slew speed should be measured by the method described hereafter (Steps 1.1 through 1.9)

No signals shall be transmitted during this part of the test.

Step 1.1: Acquire the beacon of the satellite specified in the test plan. Optimize the antenna pointing for maximum receive signal level.

Step 1.2: Move the antenna in azimuth 5° counter-clockwise.

Step 1.3: Measure the time of the azimuth movement from -5° via beamcentre to +5° (i.e. clockwise antenna motion from East to West). Calculate the azimuth slew speed in degrees per second.

Step 1.4: For motorized antennas which are not equipped with angular encoders, Steps 1.1 through 1.3 shall be repeated at least 3 times and results shall be averaged.

Step 1.5: Repeat Step 1.1.

Step 1.6: Move the antenna in elevation 5° down.

Step 1.7: Measure the time of the elevation movement from -5° via beamcentre to +5° (i.e. ascending antenna motion). Calculate the elevation slew speed in degrees per second.

Step 1.8: If applicable, repeat Step 1.4.

Step 1.9: Report results prior to commencement of ESVA to the Eutelsat System Verification Test Section.

B. POWER BALANCE

Step 2: ERS transmit the reference carrier at the frequency and EIRP as specified in the Eutelsat test plan.

Step 3: ERS perform a calibration of the satellite loop by recording the ERS carrier for an EIRP range of 60 dB below the initial value in 10 dB steps. Proceed with step 6 if co-polar patterns only are recorded.

Step 4: ERS transmit the reference carrier via the cross-polar channel at EIRP (generally from 20 to 40 dB below co-polar) and frequency as specified in the Eutelsat test plan.

Step 5: ERS measure the difference in level between the reference carrier and the cross-polar component of the carrier under test. ERS compute the cross-polar antenna gain of the SUT.

Step 6: SUT adjust the EIRP setting to obtain the value specified in the Eutelsat test plan. Under direction of the ERS, SUT commence transmission at the frequency established during the satellite access test.

Step 7: If necessary, SUT adjust the EIRP under control of ERS to balance the reference carrier.

Step 8: ERS confirm balance condition.

Step 9: ERS cease transmission of the reference carrier.

C. AZIMUTH PATTERN

- Step 10: Considering the outcome of the Satellite Access Test, ERS optimize spectrum analyser settings for reception of the SUT carrier.
- Step 11: Upon request by the ERS, SUT interrupt transmission for a short interval. ERS proceed with optimization of analyse settings. SUT activate carrier on request of ERS.
- Step 12: Under direction of the ERS, SUT move the antenna starting from boresight to the "counter clockwise" limit (i.e.: to the East). The value of the East limit (e.g. -25° off beamcentre) is stated in the test plan. ERS verify the antenna slew speed.
- Step 13: In close coordination with the ERS (Figure 9.3), SUT move the antenna to the "clockwise" limit (i.e.: from the start position via boresight to the West). The value of the West limit (e.g. 25° off beam centre) is stated in the test plan. ERS record the co- and cross-polar patterns.
- Step 14: SUT switch off the carrier and return to boresight. Under the direction of the ERS, SUT recommence transmission and optimise antenna pointing for maximum receive level. SUT cease transmission if no further antenna measurements follow.
- Step 15: Process measurement data and produce plots of co-polar azimuth and elevation antenna TX diagrams including the appropriate masks. In case major anomalies in the patterns are identified, the results are reviewed internally. A suspension of the ESVA may be decided in case non-compliances with respect to Eutelsat standards are detected.

D. ELEVATION PATTERN

- Step 16: Under direction of the ERS, SUT move the antenna starting from boresight to the "lower" limit (i.e. from start position via boresight down). The value of the lower limit is stated in the test plan (e.g. -15° off beam centre). ERS verify the antenna slew speed.
- Step 17: In close coordination with the ERS (Figure 9.3 refers), SUT move the antenna from the "lower" limit via boresight to the "upper" limit (e.g. $+15^\circ$ off beam centre). The value of the upper limit is stated in the test plan. ERS record the co- and cross-polar patterns.
- Step 18: SUT switch off the carrier and return to boresight. Under direction of the ERS, SUT recommence transmission and optimize antenna pointing for maximum receive level. SUT cease transmission if no further antenna measurements follow.
- Step 19: Process measurement data and produce plots of co-polar azimuth and elevation antenna TX diagrams including the appropriate masks. In case major anomalies in the patterns are identified, the results are reviewed internally. A suspension of the ESVA may be decided in case non-compliances with respect to Eutelsat standards are detected.

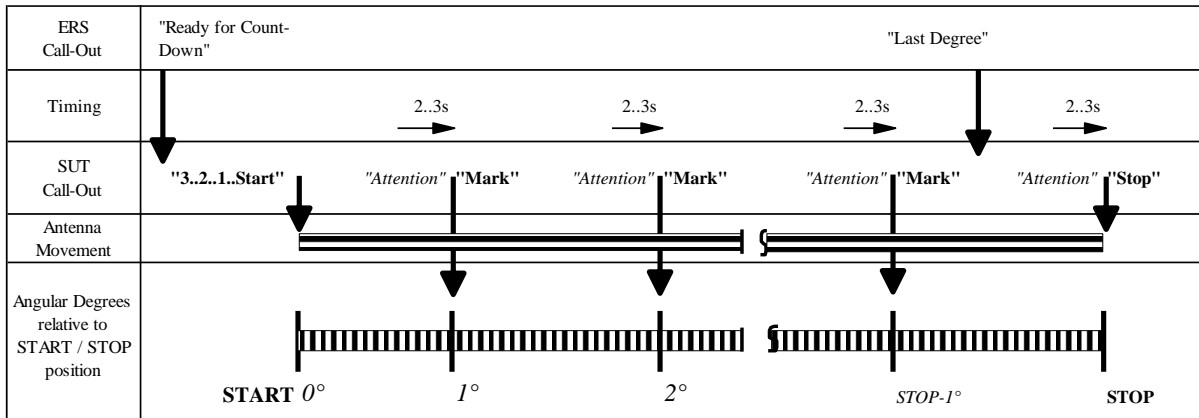

Figure 9.3: Coordination Scheme during Antenna Pattern Measurements.

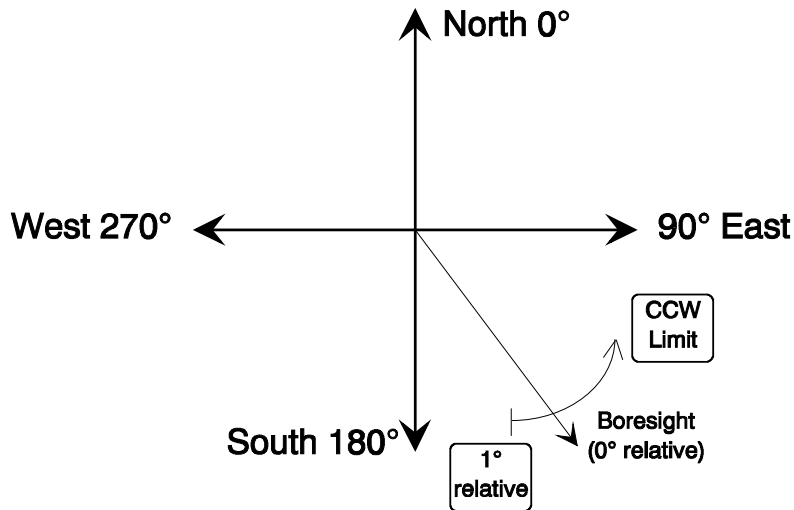

Figure 9.4: Terminology for Azimuth Antenna Movement.

Cut Nr.	Azimuth/Elevation	Antenna Movement	Direction
1	Az	+1° to CCW limit	Towards East
2	Az	-1° to CW limit	Towards West
3	EI	+1° to lower limit	Down
4	EI	-1° to upper limit	Up

CCW : Counter-clockwise CW : Clockwise

Table 9.1: Summary of Antenna Pattern Measurement.

Note 1: Relative azimuth angles are not corrected for non-orthogonality. They are therefore equivalent to angular encoder readout at the earth station.

Note 2: To achieve constant slew speed during the measurement and thus avoiding errors due to acceleration, the actual start position is offset from the first-degree mark. The offset

depends on the antenna slew speed and it is typically between 0.5° and 1°. The SUT may propose a suitable value.

9.4 Example for Spectrum Analyser Settings

Reference level:	: As applicable
Attenuator	: 0 dB
Scale	: 10 dB/Division
Centre frequency	: SUT down-link frequency as per test plan (11 or 12 GHz range)
Span	: 0 Hz
Resolution bandwidth	: 30 Hz (or 10 Hz)
Video bandwidth	: 1 Hz
Sweep time	: According to antenna slew speed e.g. 500 sec.
Marker noise	: OFF
D-Marker	: OFF
Trace	: Clear write
Display line	: Position to noise floor

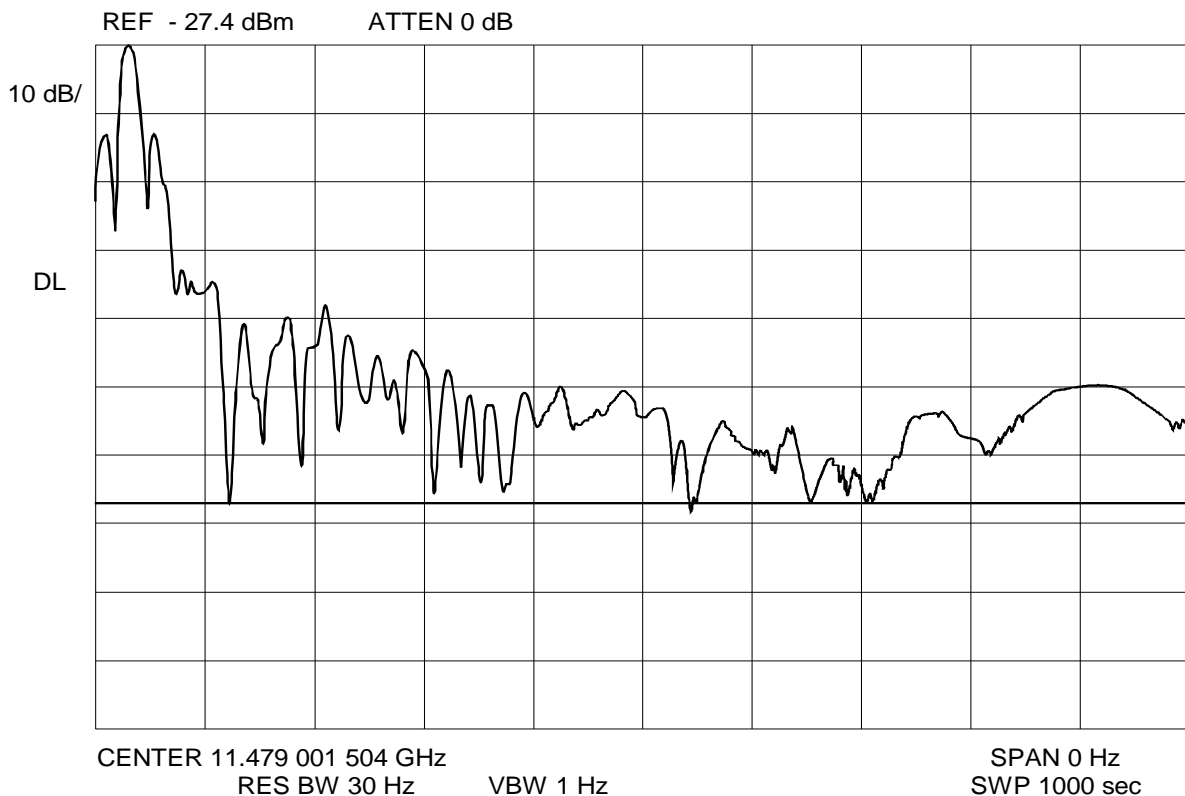

Figure 9.5: Spectrum Analyser Display during Antenna Pattern Measurement.

10 G/T

10.1 Test Objectives

To measure the gain-to-equivalent noise temperature ratio (G/T) of the earth station receive section.

Verification of correct function of the receive chain(s) by confirmation of the expected G/T value at IF interface.

10.2 Principle

In contrast to separate evaluation of antenna gain and system noise temperature, the following procedure implies the direct measurement of the G/T. Therefore, it is required to measure the receive level (P_C) of a reference carrier at the station under test. Then, the antenna under test is pointed to the cold sky and the noise level (P_N) is measured in a defined bandwidth. From these two values, the G/T is computed.

$$G/T_{SUT} = L_{fs,SUT} + L_{at,SUT} + B + K - EIRP_{SAT,SUT} + R \quad \text{Equation 10-1}$$

$$R = 10 \cdot \log_{10} [10^{(P_C - P_N)/10} - 1] \quad \text{Equation 10-2}$$

If

$$P_C - P_N > 20, \quad \text{Equation 10-3}$$

the expression Equation 10-2 may be simplified to:

$$R \cong P_C - P_N \quad \text{Equation 10-4}$$

Where:

G/T_{SUT}	: Gain to equivalent noise temperature ratio of SUT	[dB/K]
$L_{fs,SUT}$: Free space loss towards SUT = $20 \cdot \log(4 \cdot B \cdot d \cdot f / c)$	[dB]
	f = frequency (Hz)	
	d = distance (m)	
	c = 299792458 (m/s)	
$L_{at,SUT}$: Atmospheric attenuation at SUT	[dB]
B	: Equivalent noise bandwidth [dBHz]	
K	: Boltzmann's constant:	
	$(1.38051 \cdot 10^{-23} \text{ Ws/K} \cong -228.60 \text{ dBWs/K})$	[dBWs/K]
$EIRP_{SAT,SUT}$: Satellite EIRP towards SUT	[dBW]
P_C	: Carrier level (C + N)	[dBm]
P_N	: Noise level (N)	[dBm]
R	: Power ratio $\left(\frac{C+N}{N}\right)$	[dB]

NOTE: For the atmospheric attenuation, the following values are assumed under clear sky conditions: 11 GHz range: 0.20 dB 12 GHz range: 0.25 dB

NOTE: For spectrum analyser measurements, Equation 10-3 must be valid at resolution bandwidth even if readout is normalized to 1 Hz.

The satellite EIRP towards the SUT is computed from the measured value of satellite EIRP towards the ERS.

$$EIRP_{SAT,SUT} = EIRP_{SAT,ERS} + L_{OA,ERS} - L_{OA,SUT} \quad \text{Equation 10-5}$$

where:

$EIRP_{SAT,ERS}$: Satellite EIRP towards ERS	[dBW]
$L_{OA,ERS}$: Off-axis loss towards ERS	[dB]
$L_{OA,SUT}$: Off-axis loss towards SUT	[dB]

As the measurement is generally carried out by a spectrum analyser, corrections of the displayed noise level for bandwidth and detection must be applied. In modern analysers this correction is achieved by an internal routine which provides a direct readout of the normalized noise level (noise marker). Where this facility is unavailable, the operator must refer to the relevant instrument application notes (e.g. HP 8-series) to obtain the applicable values.

The following figures for correction of the displayed noise level are typical:

Translation from resolution bandwidth to noise bandwidth:	-0.8 dB
Combined correction for detector characteristics and logarithmic shaping:	+2.5 dB
The total typical correction is therefore:	+1.7 dB.

In this case, the actual noise level is 1.7 dB higher than the displayed figure. Therefore the "displayed" C/N is 1.7 dB better than the actual value of C/N.

Care must be taken to avoid inaccuracy of the noise level measurement due to the contribution of the spectrum analyser. To confirm correct function of the whole receive chain, it is recommended to carry out the measurement at RF and IF level.

10.3 Step-by-Step Procedure

A. TRANSMISSION OF REFERENCE CARRIER

Step 1: ERS transmit the reference carrier at the frequency and EIRP as specified in the Eutelsat test plan.

NOTE: Disregard Step 1 if the G/T measurement is performed using the satellite beacon.

B. MEASUREMENT OF CARRIER LEVEL

Step 2: ERS measure the satellite EIRP of the reference carrier and compute the corresponding EIRP towards the SUT.

Step 3: With the antenna at boresight, SUT measure the reference carrier level at RF and IF interfaces in dBm/Hz. For beacon measurements, the applicable resolution bandwidth shall be agreed between ERS and SUT. Examples are reported in Figure 10.1 and Figure 10.2. SUT report the value to the ERS.

C. MEASUREMENT OF NOISE LEVEL

Step 4: At a small frequency offset (e.g. 100 kHz), SUT measure the noise level in dBm/Hz.

Step 5: SUT move the antenna off to the satellite, preferably in azimuth by at least 5°. While slewing the antenna, SUT monitor the noise level. The antenna movement may be stopped when the noise level does no longer decrease.

Step 6: SUT terminate the spectrum analyser input and read the noise level. Report the value to the ERS.

Step 7: SUT connect the spectrum analyser to the RF interface. With identical settings of Steps 5, 6 above, SUT measure the noise level (Figure 10.3). SUT reports the value to the ERS.

Step 8: Repeat Step 7 with the analyser connected to the IF interface.

D. EVALUATION

Step 9: If applicable, SUT report the relevant correction factors and the bandwidth to ERS. SUT return the antenna to boresight.

Step 10: ERS communicate value of the satellite EIRP to SUT and calculate the value of the G/T.

NOTE: Given the measured parameter are not constant over time the whole procedures shall be performed at once in the shortest possible timeframe to ensure meaningful results.

10.4 Example for Spectrum Analyser Settings

Measurement of Carrier Level (Note: ERS may advice to apply different settings)

Reference level:	: 5 dB above level of reference carrier
Attenuator	: 0 dB
Scale	: 10 dB/Division
Centre frequency	: ERS down-link frequency as per test plan (RF or IF range)
Span	: 100 kHz
Resolution bandwidth	: 3 kHz
Video bandwidth	: 100 Hz
Video average	: ON (10 samples)
Sweep time	: Auto (typically 1.5s)
Marker noise	: OFF
Δ-Marker	: OFF, Marker peak search
Trace	: Clear write A

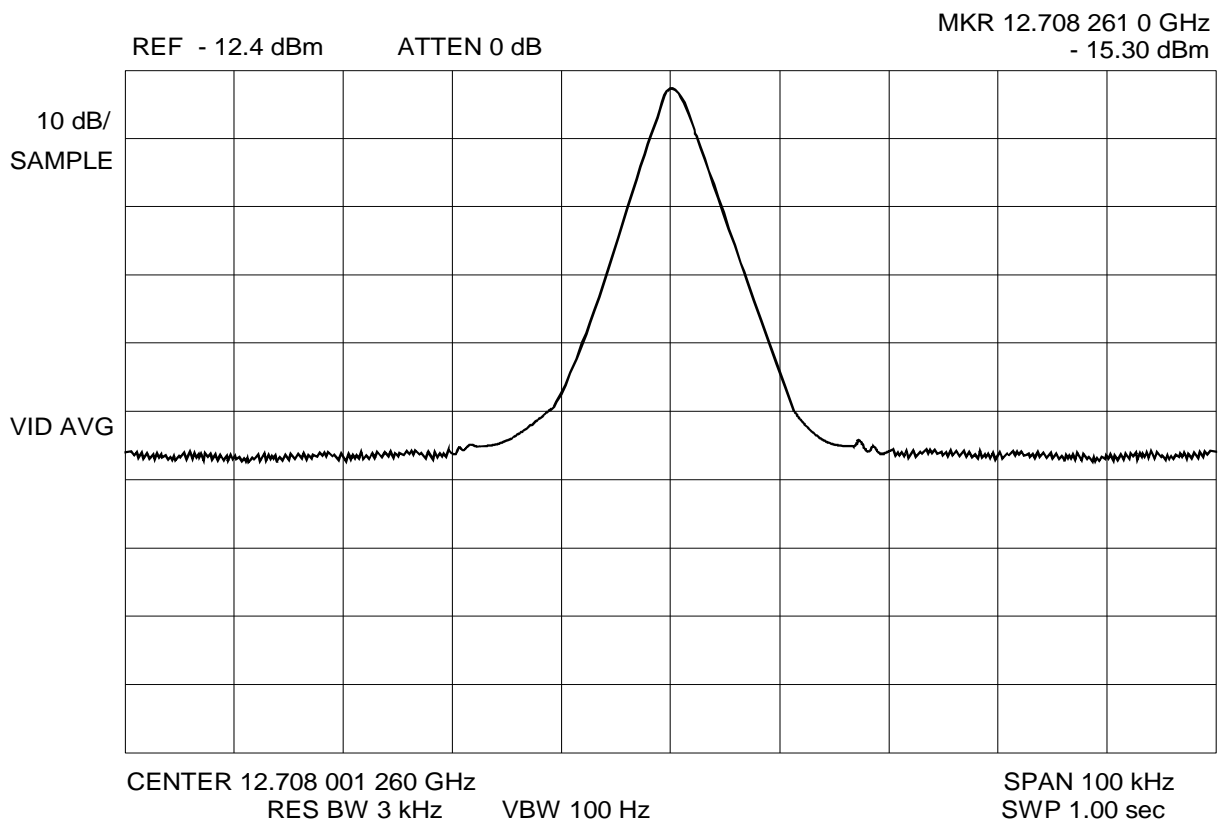

Figure 10.1: Spectrum Analyser Display during G/T Measurement (Carrier level).

NOTE: The example applies to measurements where the spectrum analyser is connected to the LNA output. In case of measurements at IF, the attenuator has to be set according to the actual level (in order to avoid over drive).

Measurement of Beacon Level (Note: ERS may advice to apply different settings)

Reference level:	: 5 dB above beacon level
Attenuator	: 0 dB
Scale	: 10 dB/Division
Centre frequency	: Beacon frequency as per test plan (RF or IF range)
Span	: 1 MHz
Resolution bandwidth	: 3 kHz
Video bandwidth	: 30 Hz
Video average	: ON (10 samples)
Sweep time	: Auto (typically 1.5s)
Marker noise	: OFF
Δ-Marker	: OFF, Marker peak search
Trace	: Clear write A

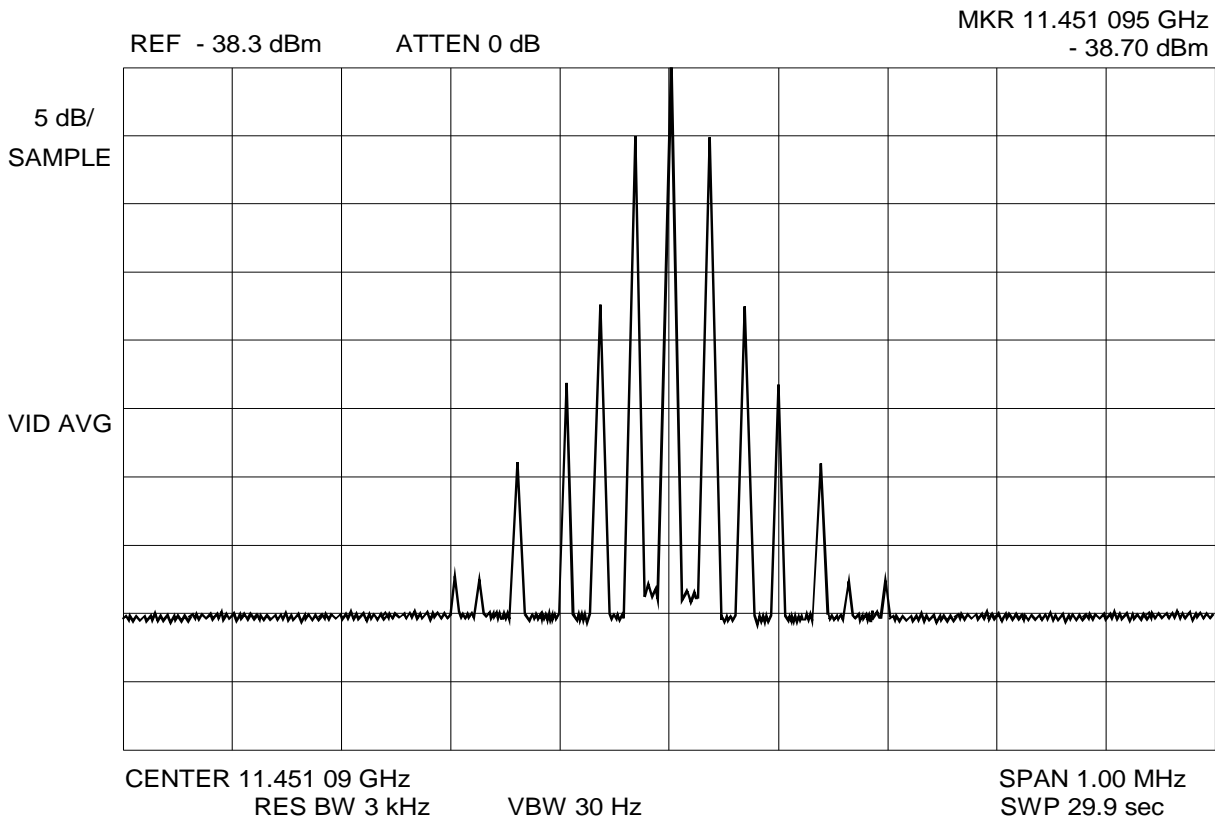

Figure 10.2: Spectrum Analyser Display during G/T Measurement (Carrier Level).

Measurement of Noise Level (Note: ERS may advice to apply different settings)

Reference level:	: 5 dB above noise floor
Attenuator	: 0 dB
Scale	: 10 dB/Division
Centre frequency	: Beacon frequency as per (RF or IF range)
Span	: 100 kHz
Resolution bandwidth	: 3 kHz
Video bandwidth	: 100 Hz
Video average	: ON (10 samples)
Sweep time	: Auto (typically 1.5s)
Marker noise	: ON
Marker Frequency	: 200 kHz below carrier beacon frequency
Δ-Marker	: OFF
Trace	: Clear write A
Display line	: ON

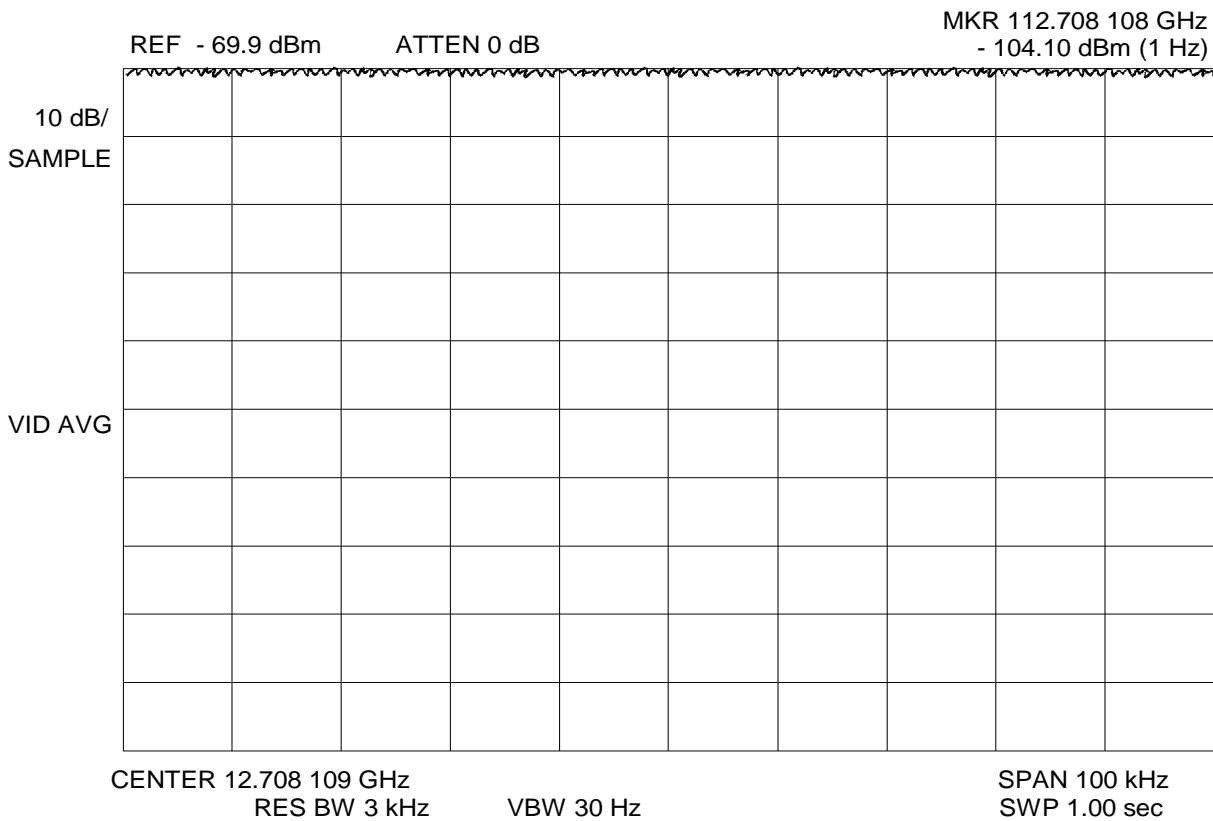

Figure 10.3: Spectrum Analyser Display during G/T Measurement (Noise Level).

NOTE: The above (para. 10.4) are generally applicable if the spectrum analyser is connected to an LNA output. The attenuator setting to 0 dB may be inappropriate in case of connection to the output of a down-converter, line-amplifier, etc. In any case, the carrier level indicated must be independent of the attenuation setting, i.e. when changing the attenuator, no change of carrier level should be observed.

11 RECEIVE POLARIZATION DISCRIMINATION

11.1 Test Objectives

To measure the receive polarization isolation of the station under test at optimized TX polarization alignment. The measurement is carried out at boresight and at 8 samples within the 1 dB contour of the co-polar antenna RX pattern.

Although the measurement is not mandatory, it is recommended and it will provide additional aspects for the evaluation of the overall antenna performance.

11.2 Principle

The ERS transmits a carrier via a Eutelsat satellite and maintains a constant flux. Then at optimum TX polarization alignment (Chapter 6 refers), the Station Under Test measures the co-polar and the cross-polar component of the reference carrier by comparison to an injected signal. From the difference in level, the RX-XPD of the SUT is computed.

Possible inaccuracies can be due to the up-link (i.e. ERS, TX-XPD, satellite RX-XPD).

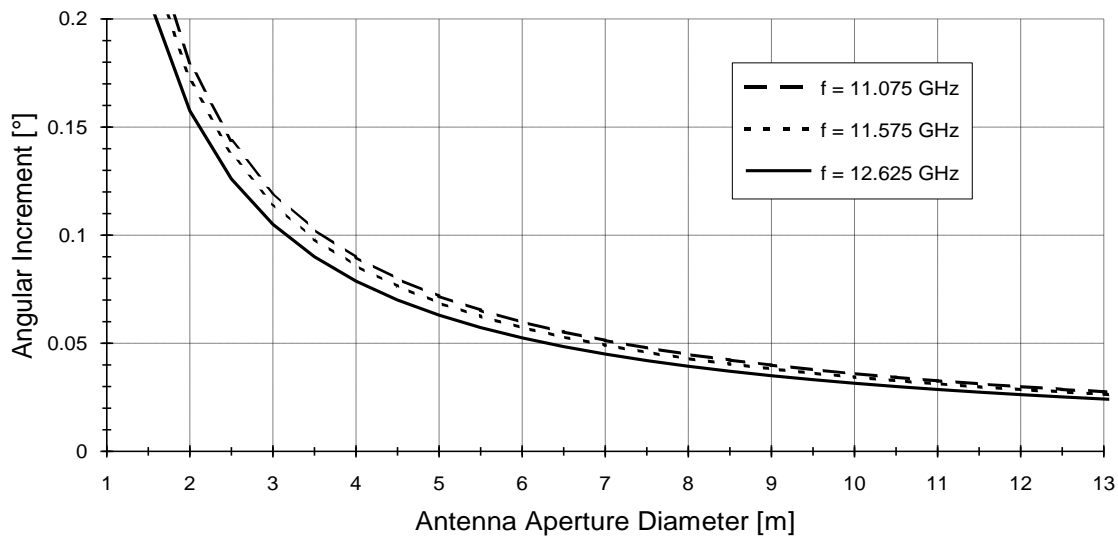

Figure 11.1: Angular Increment (AI) for RX-XPD Measurements.

To verify the performance of the SUT antenna within the co-polar -1 dB RX contour, the SUT antenna is depointed in azimuth and elevation as described in Figure 8.1 and the measurement is conducted at each point (boresight and 8 samples). The angular increment (AI) may be estimated by formula (1) of paragraph 11.2.

To ensure accurate positioning of the antenna, a SUT equipped with a 4-port feed monitors the variation of the co-polar RX level of the reference carrier. For SUT equipped with a 2-port feed, the reference carrier shall be transmitted via X polarization (i.e. received via Y polarization). Hence, the SUT measures the cross-polar component of the reference carrier and monitors the variation of the satellite beacon level via the same (X) polarization.

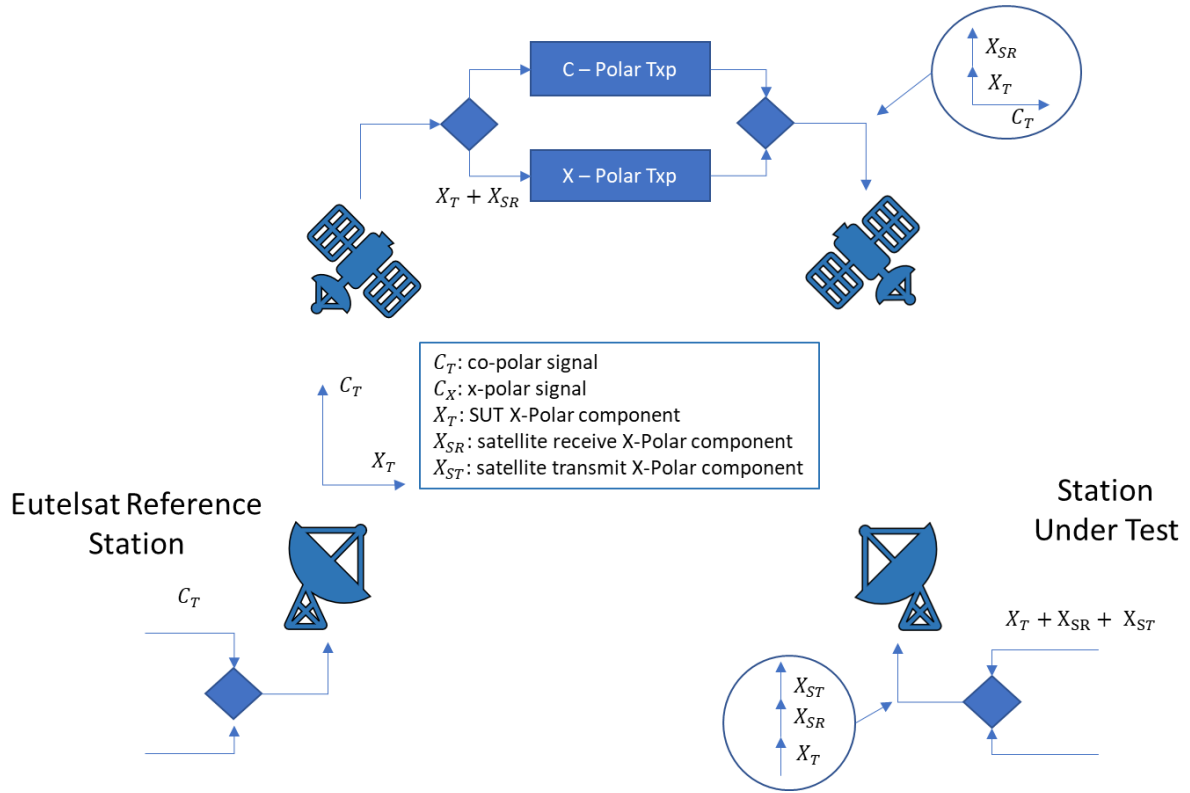

Figure 11.2: Schematic Representation of the RX-XPD Measurement.

11.3 Step-by-Step Procedure

NOTE: Optimum TX-polarization alignment must be assured prior to this test. For SUT equipped with a 4-port feed the alignment of para. 6.3 remains unchanged and commutation from X to Y polarization is done by switching.

NOTE: For SUT equipped with a 2-port feed, the optimum polarization alignment must be established for the Y-plane. If this has not been accomplished, test 5.2 must be repeated prior to the following measurements.

Step 1: During ESVA preparation and prior to commencement of ESVA testing, SUT check the linearity of the RX-chain(s) as follows:
A test signal at stable amplitude and frequency (i.e. the in-station pilot) is injected at the input of the LNA. By means of a microwave attenuator, the pilot level is reduced in 10 dB steps and the corresponding power levels displayed on the spectrum analyser are recorded. This establishes a reference scale and a check of the linearity of the RX-chain(s) including the analyser display.

Step 2: SUT equipped with 2-port feed proceed with Step 5.

Step 3: SUT inject the pilot into one of the RX chains and measure its level.

Step 4: Under consideration of differences in the RX coupling factors, inject the same pilot level into the second RX chain and measure the difference relative to the value obtained in Step 3 above. The result is the correction factor (i.e. the RX gain difference) for the following RX-XPB measurements.

Step 5: ERS transmit the reference carrier at frequency and EIRP as specified in the Eutelsat test plan.

Note: If the SUT is equipped with a 2-port feed, the test plan shall provide a channel with X polarization in up-link and Y polarization in down-link.

Step 6: SUT receive the co-polar component of the reference carrier. Set the pilot frequency close to the RX-frequency of the reference carrier (e.g. $f_{PILOT} = f_{REF} - 200 \text{ Hz}$).

Step 7: ERS transmit the reference carrier via the co-polar channel at the frequency and EIRP as specified in the Eutelsat test plan.

SUT equipped with 4-port feed proceed with Step 9.

Step 8: SUT rotate the antenna feed by 90° and ensure that this position corresponds to the optimum TX polarization alignment established during test 4.2 (compare angular readout and/or marks on feed).

SUT equipped with 2-port feed proceed with Step 10.

Step 9: SUT switch to orthogonal channel.

Step 10: SUT lock to the cross-polar component of the reference carrier and measure the difference in level between the pilot and the cross-polar component of the reference carrier. If necessary, apply a correction (Step 4 above) and determine the XPB.

Step 11: SUT lock to the co-polar component of the reference carrier (the satellite beacon for SUT equipped with 2-port feed). Move the antenna off boresight according to Figure 8.1. While moving the antenna, SUT monitor the variation of the RX level and control the movement accordingly, (Table 8.1 refers).

Step 12: Repeat Steps 11 and 12 for each point of the sequence described in Figure 8.1.

Step 13: SUT report results to Eutelsat.

11.4 Example for Spectrum Analyser Settings

Co-polar Reception

Reference level:	: As applicable
Attenuator	: 0 dB
Scale	: 5 dB or 10 dB/Division
Centre frequency	: ERS down-link frequency as per test plan (11 or 12 GHz range)
Span	: 2 kHz
Resolution bandwidth	: 30 Hz
Video bandwidth	: 30 Hz
Video average	: OFF
Sweep time	: Auto
Marker noise	: OFF
Δ-Marker	: activated
Trace	: Max. Hold A
Display line	: OFF

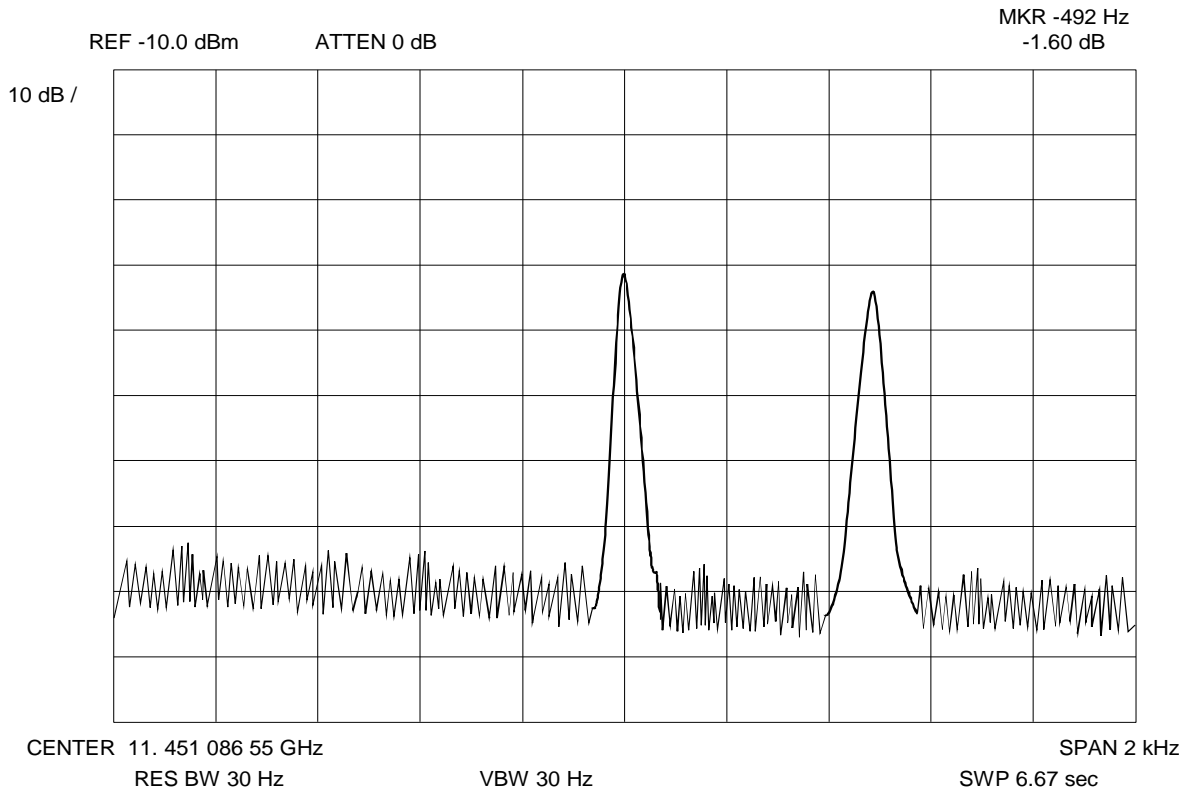

Figure 11.3: Spectrum Analyser Display during RX-XPD Measurement Co-Polar Reception.

Cross Polar Reception

Reference level:	: As applicable
Attenuator	: 0 dB
Scale	: 5 dB or 10 dB/Division
Centre frequency	: ERS down-link frequency as per test plan (11 or 12 GHz range)
Span	: 2 kHz
Resolution bandwidth	: 30 Hz
Video bandwidth	: 30 Hz
Video average	: OFF
Sweep time	: Auto
Marker noise	: OFF
Δ-Marker	: activated
Trace	: Max. Hold A
Display line	: OFF

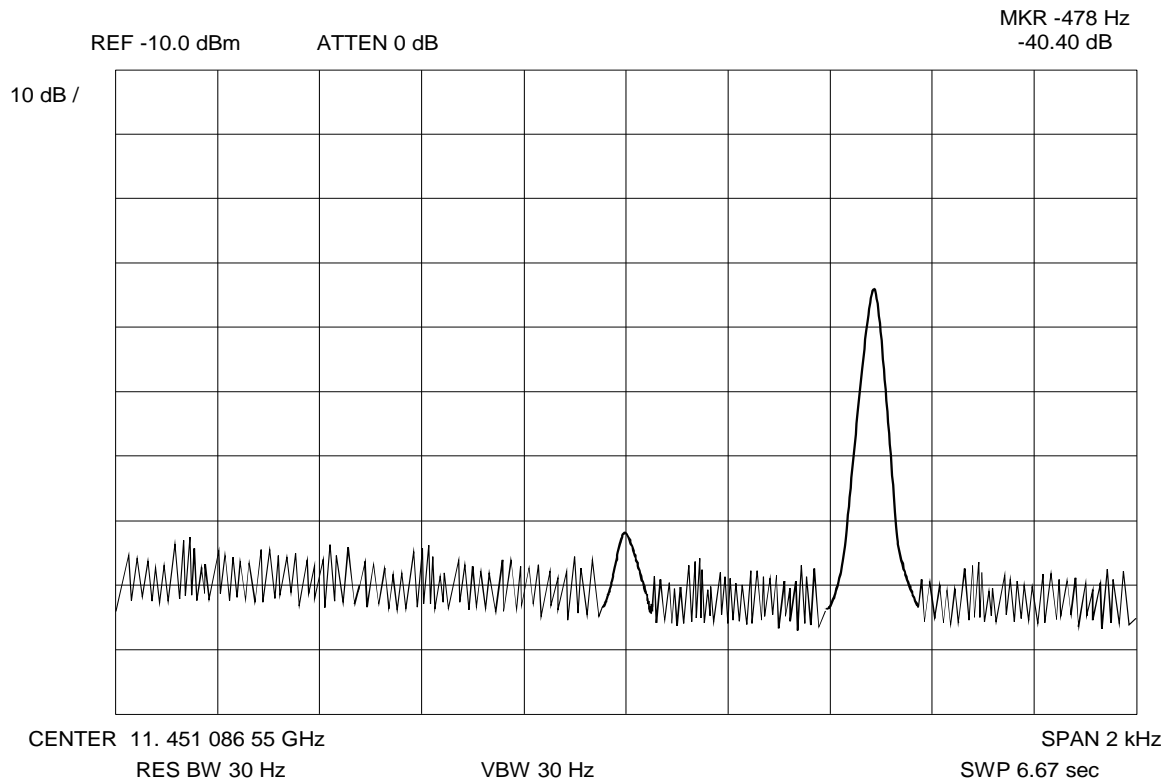

Figure 11.4: Spectrum Analyser Display during RX-XPD Measurement.

12 RECEIVE SIDELOBES (INCLUDING RECEIVE GAIN)

12.1 Test Objectives

To record the receive antenna diagram of the station under test. Although the measurement is not mandatory, it is recommended and it will provide additional aspects for the evaluation of the overall antenna performance.

12.2 Principle

12.2.1 Antenna Pattern

The ERS transmits a carrier via an Eutelsat satellite and maintains a constant flux. Alternatively, the station under test may lock to a satellite beacon signal. Then, the station under test records the receive level as function of the slewing angle in azimuth and elevation. Due to the non-orthogonality of the rotational axes, the azimuth angle is corrected according to formula 1 of paragraph 9.2.1. For evaluation of the antenna performance, the envelope of Figure 9.2 is applied.

12.2.2 Receive Gain

If the station under test is equipped with a receive coupler, the antenna receive gain may be calculated at known satellite EIRP. During ESVA preparation, the values of the RX coupling factor and the loss between the RX coupler and the antenna flange (or interface where the antenna gain is defined) have to be obtained by in-station measurement.

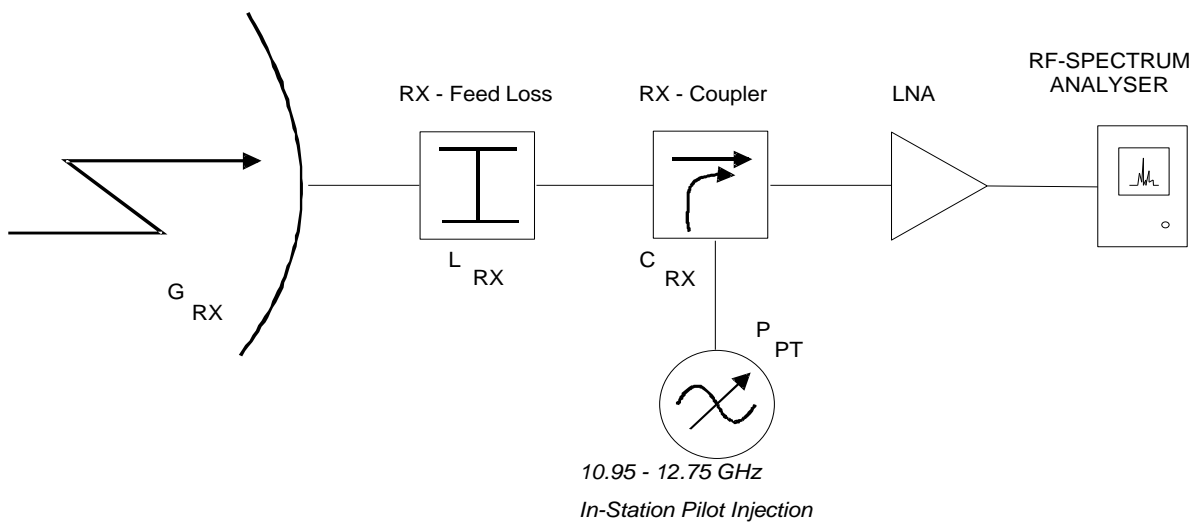

Figure 12.1: Block Diagram of SUT RX-Chain.

At known satellite EIRP, the RX gain is given by:

$$G_{RX} = P_{Pt} + L_{RX} - C_{RX} - (EIRP_{SAT,SUT} - L_{fs,SUT} - L_{at,SUT} + 30) \quad \text{Equation 12-1}$$

where:

G_{RX}	: Antenna receive gain of SUT[dBi]	
L_{RX}	: RX feed Loss	[dB]
P_{Pt}	: Level of in-station pilot at injection point	[dBm]
C_{RX}	: RX coupling factor	[dB]
$EIRP_{SAT,SUT}$: Satellite EIRP towards SUT[dBm]	
$L_{fs,SUT}$: Free space loss towards SUT	[dB]
$L_{at,SUT}$: Atmospheric loss for reception at SUT	[dB]
30	: Conversion dBW ==>dBm[dB]	

The satellite EIRP towards the SUT is computed from the measured value of satellite EIRP towards the ERS.

$$EIRP_{SAT,SUT} = EIRP_{SAT,ERS} + L_{OA,ERS} - L_{OA,SUT} \quad \text{Equation 12-2}$$

where:

$EIRP_{SAT/ERS}$: Satellite EIRP towards ERS	[dBW]
$L_{OA/ERS}$: Off-axis loss towards ERS	[dB]
$L_{OA/SUT}$: Off-axis loss towards SUT	[dB]

To appreciate the measurement results, the theoretical expected value of the receive gain may be calculated according to Equation 7-3 of para. 7.2.4.

12.3 Step-by-Step Procedure

A. TRANSMISSION OF REFERENCE CARRIER

Step 1: ERS transmit the reference carrier at the frequency and EIRP as specified in the Eutelsat test plan.

NOTE: Disregard Step 1 if the antenna measurement is performed using the satellite beacon.

B. CALIBRATION OF RECEIVE CHAIN

Step 2: With the SUT antenna at boresight, SUT adjust the spectrum analyser and confirm linearity of receive and test equipment. If the SUT is not equipped with a receive coupler go to Step 6.

Step 3: Verification of linearity may be achieved by injection of an in-station pilot via a coupler prior to the LNA input. The pilot level shall be equal to the received carrier at frequency which is approximately 10 kHz apart.

Step 4: SUT communicate receive coupling factor and receive feed loss to ERS. ERS evaluate satellite EIRP towards SUT and calculate antenna receive gain.

Step 5: SUT report the in-station pilot level at the LNA output and reduce the pilot in 10 dB steps from relative 0 dB to –50dB.

C. AZIMUTH PATTERN

Step 6: SUT remove the in-station pilot and lock to the reference carrier. Except for the centre frequency, all analyser settings must remain unchanged from Step 5.

Step 7: SUT move the antenna counterclockwise (i.e. to the East) in azimuth until the receive level is in the order of the noise floor (e.g. to –20°).

Step 8: While recording the receive level, SUT slew the antenna in azimuth via boresight to the corresponding clockwise (i.e. West) position (e.g. +20°).

Step 9: SUT slew the antenna to beam centre and optimize pointing for maximum receive level.

D. ELEVATION PATTERN

Step 10: SUT descend the antenna in elevation until the receive level is in order of the noise floor (e.g. –15°).

Step 11: While recording the receive level, SUT rise the antenna in elevation via boresight to the corresponding upper position (e.g. +15°).

Step 12: SUT slew the antenna to beam centre and optimize pointing for maximum receive level.

Step 13: SUT process measurement data and produce plots of the co-polar azimuth and elevation antenna receive diagrams including the appropriate envelopes.

Step 14: SUT inform ERS of measurement conclusion and forward results to Eutelsat.

12.4 Example of Spectrum Analyser Settings

Reference level:	: As applicable
Attenuator	: 0 dB
Scale	: 10 dB/Division
Centre frequency	: SUT down-link frequency as per test plan (11 or 12 GHz range)
Span	: 0 Hz
Resolution bandwidth	: 30 Hz (or 10 Hz)
Video bandwidth	: 1 Hz
Sweep time	: According to antenna slew speed, e.g. 500 sec.
Marker noise	: OFF
Δ-Marker	: OFF
Trace	: Clear write
Display line	: Position to noise floor

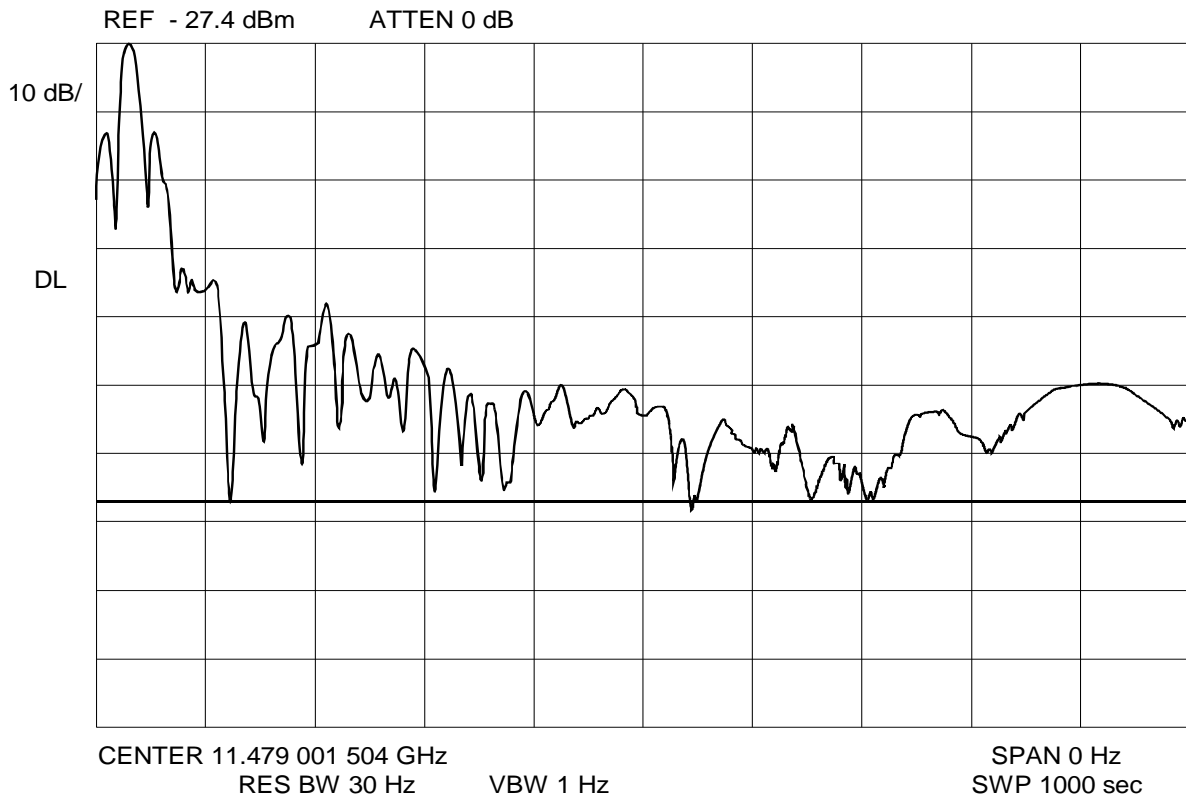

Figure 12.2: Spectrum Analyser Display during Antenna Pattern Measurement.

Annex A - Questionnaire

The form on the next page is used to provide Eutelsat with specific data relevant to any forthcoming ESVA or Earth Station Test activity. This information is required to ensure smooth implementation of measurements and is normally not part of the Eutelsat Earth Station database. With submission of the completed form, the station operator re-confirms and guarantees his adequate preparation and readiness for test activities.

ESVA Questionnaire for E/S: _____

1. Availabilities

Preferred date(s) for the test: _____ (TBC by ERS) Preferred start time (UTC): _____

Remarks: _____

2. E/S Parameters

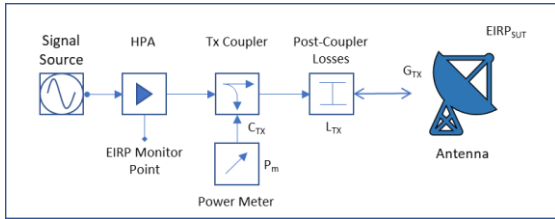

Station reference gain:

G_{TX} : _____ [dBi]

At frequency: _____ [GHz]

Note: Unless stated otherwise, antenna diagrams will be normalized to typical antenna gain, i.e. 65% efficiency, at test frequencies.

EIRP calibration performed via monitor points applicable to forthcoming operations: Yes No

TX Chain Designation	HPA 1	HPA 2	Other: _____
TX Coupling Factor C_{TX} [dB]			
Post Coupler Loss L_{TX} [dB]			

Receive pattern is attached Yes No

Earth station block diagram is attached Yes No

3. E/S Configuration

Usable Frequency Range for ESVA

Up-Link _____ - _____ GHz Down-Link _____ - _____ GHz

Antenna Motorisation None Mechanic Electrical
(Handwheel/Leadscrew)

Az/EI Encoding None Physical Marks Digital

Geostationary Visibility (Longitude From-To) _____° - _____°

Test Equipment Type

Signal Source _____
 Power Meter _____
 Spectrum Analyzer _____

Feed Type

2-Port 4-Port

Polarization

Linear Circular

Polarization Plane Adjustment Range

+ / - : _____°

Antenna Slew Speed

(if motorised and at lowest speed settings)

Azimuth: _____°/s

Elevation: _____°/s

Antenna Coordinates

(for transportable E/S indicates location of test)

Latitude: _____° N S

Longitude: _____° E W

4. Contact Points

Station Manager Name: _____ Phone: _____ e-mail: _____

Contact during ESVA Name: _____ Phone: _____ e-mail: _____

5. Remarks (for missing information please specify reason)

Annex B - List of Abbreviations

AI	Angular Increment
C/N	Carrier to Noise Ratio
CCIR	International Radio Consultative Committee (Comité Consultatif International de Radiocommunications)
CCW	Counter-Clockwise
CSC	Eutelsat Communications System Control Centre
CW	Clockwise
CW	Continuous Wave (clean carrier)
E/S	Earth Station
EIRP	Equivalent Isotropic Radiated Power
ERS	Eutelsat Reference Station
ESOG	Eutelsat System Operations Guide
ESVA	Earth Station Verification Assistance
G/T	Gain to Equivalent Noise Temperature Ratio
HPA	High Power Amplifier
IF	Intermediate Frequency
IPFD	Input Flux Density
LNA	Low Noise Amplifier
LNB	Low Noise Block Converter
LNC	Low Noise Converter
RF	Radio Frequency
RX	Receive
SUT	Station Under Test
TX	Transmit
UTC	Universal Time Coordinate
XDR	Transponder
XPD	Cross-Polarization Discrimination

Annex C - Measurement of Spurious Radiation

C.1 Test Objectives

- Confirm compliance with spurious radiation specifications.
- Prevent any interference to existing services.

C.2 Principle

The SUT transmits at nominal power to dummy load or clear sky (i.e. far off the geostationary arc) at operational configuration. Using a calibrated measurement point of the station transmit (TX) chain, the output signal is examined within a suitable frequency range for the presence of spurious and intermodulation products.

The following procedure is intended to provide enough indication of presence of spurious emissions. Further investigation (e.g.: zooming into the frequency band where a suspect spurious signal occurs) will be required if spurious signals are detected during this measurement.

C.3. Summary of Requirements

Although the specifications vary following E/S standard, a reasonably simple way to check compliance is to take spectrum analyser dumps of the frequency range of interest. It is however required that SUT provides at least a way to keep a copy of the trace (plotter, screen snapshot, computer file), copy which shall be forwarded (fax or e-mail) to ERS/Eutelsat for evaluation.

Furthermore, the SUT shall record the relevant levels observed using the spectrum analyser marker functions.

Eutelsat Specification	E/S standard	Spurious excluding Intermodulation				Intermodulation Products		Spectral Sidelobes	
		Outside alloc. BW		Inside alloc. BW		Level (dBW)	Meas. BW (kHz)	Level (dBW)	Meas. BW (kHz)
		Level (dBW)	Meas. BW (kHz)	Level (dBW)	Meas. BW (kHz)				
EESS 200	T-2	4	4	N/A	N/A	12	4		
EESS 203	I	4	4	TX carrier -50 dB	4	12	4		
EESS 400	L	4	4			7	4		
						12	4	12	4
						42	12500	42	12500
EESS 500	S	4	4	TX carrier -50 dB					
EESS 502	M	4	4	TX carrier -50 dB		12		TX carrier -50 dB	

C.4. Test conditions

- HPA to dummy load or antenna pointed to clear sky.
- Signal generated by the operational modulator, routed through the operational up-converter.(SUT in operational configuration).
- SUT HPAs to operate at standardized input back off.
- Test Equipment (S.A.) connected to a test point which has been calibrated during ESVA.
- HPA power set using a power meter at the calibrated test point. (Use of the S.A. would be inaccurate since it is usually connected through an uncalibrated cable).

C.5. Potential Pitfalls

Linearity of S.A. log amplifier, as a wide dynamic range is used.

Noise floor of S.A.: with the typical levels observed in most stations, this will not usually cause trouble.

Noise response of S.A log amplifier/detector: see point 1.9 below.

Long sweep time (15s) for 4kHz measurements: some brief events may be lost possible remedy: let at least 10 sweeps accumulate data in max. hold mode.

Limited 1000 or 400 points frequency resolution (4kHz measurements).

Position of the measurement point in the up-link chain (if an up-link bandpass filter is present).

SUT signal modulation may be incompatible with the above S.A. settings.

The actions to take here depend obviously upon the modulation spectral characteristics and are to be solved on a case by case basis.

C.6. Step by Step Procedure

- Step 1: SUT switches to dummy load or depoints the antenna to cold sky (SUT to consider potential danger when commuting switches at high EIRP settings).
- Step 2: SUT configures the signal path as for operational transmission, i.e.: The signal is generated by the operational modulator and routed through the operational upconverter. No modulation is applied (see test conditions below).
- Step 3: SUT adjusts the EIRP to obtain the nominal transmit EIRP value, using the calibrated test point (see EIRP test). SUT records the EIRP and level readings.
- Step 4: Keeping the HPA power constant, SUT substitutes the spectrum analyser cable to the power sensor and sets the spectrum analyser (refer to recommended settings below).
- Step 5: SUT records the peak signal level on the analyser and deduces the cable loss (which should typically not exceed 5 dB).
- Step 6: SUT sets the spectrum analyser following the guidelines of table 1.7.1 below then activates the max. hold mode. After at least 10 sweeps, SUT freezes ('view') and records the trace (plotter / printer).
- NOTE: Assuming a 1000-point plot, each point represents a 500 kHz slice of the spectrum, which is 50 times larger than the resolution bandwidth. It is therefore recommended to zoom on visible spurious using a 10 MHz span, keeping same reference level, RBW and VBW.
- Step 7: Maintaining the above analyser settings, the SUT disconnects the spectrum analyser and records the level of the noise floor.
- Step 8: As step 6 but SUT uses the settings defined by table 1.7.2 below (The required data accumulation time will exceed 2 minutes).
- Step 9: SUT ceases transmission and forwards the results (copy of spectrum plots including corresponding EIRP levels of spurious signals and noise floor) to Eutelsat and ERS.

C.7. Spectrum Analyser Settings

Measurements for Detection of Spurious within 4 kHz Bandwidth:

Frequency	: 14.25 GHz	(Centre of the transmit band of interest or SUT carrier frequency)
Span	: 500 MHz	
Resolution Bandwidth	: 10 kHz	(For HP S.A. equivalent Noise Bandwidth equals $10 \times 1.2 = 12$ kHz). See note*
Video Bandwidth	: 10 kHz	See note*
Sweep Time	: 15 sec	Automatic (coupled)
RF Attenuator	: 10 dB	(Depends on level at nominal power. To optimize the dynamic range, it is recommended to set the attenuator to 0dB at test points with low level)
Max. Ref level	: 0 dBm	(Depends on RF attenuation)
Max. hold	: On	
Max. hold noise:	-73 dBm	(With HP8566A/B and 10dB RF input attenuation. At 0dB input attenuation: -83)

EUTELSAT S.A. OPERATIONS CONTACT POINTS

Eutelsat S.A. CSC	Phone: +33 1 45 57 06 66 e-mail: csc@Eutelsat.com
Systems Operations Earth Station Approval Office	Phone: +33 1 53 98 39 25 +33 1 53 98 46 13 +33 1 53 98 38 63 e-mail: esapproval@eutelsat.com
Resource Planning Engineering	e-mail: planning@eutelsat.com
Eutelsat S.A. Booking Office	Phone: +33 1 53 98 47 07 e-mail: booking@eutelsat.com
Mailing Address	Eutelsat S.A. 23, boulevard Gallieni 92130 Issy-les-Moulineaux FRANCE
Eutelsat S.A. Web Site	http://www.eutelsat.com

Eutelsat is one of the world's leading and most experienced operators of communications satellites.

Our extensive network of high-performance satellites, located between 133° West and 174° East, provides capacity to clients that include broadcasters and broadcasting associations, pay-TV operators, video, data and Internet service providers, enterprises and government agencies.

Eutelsat's satellites provide ubiquitous coverage of Europe, the Middle East, Africa, Asia-Pacific and the Americas, enabling video, data, broadband and government communications to be established irrespective of a user's location.

Headquartered in Paris, with offices and teleports around the globe, Eutelsat represents a workforce of 1,200 men and women from 46 countries who are experts in their fields and work with clients to deliver the highest quality of service.

What can we do for you? Please visit
www.eutelsat.com/enquiries

